

GDM-5010PT

SERVICE MANUAL

N. Hemisphere Model
S. Hemisphere Model
Korea Model
Japan Model
Chassis No. SCC-L04F-A

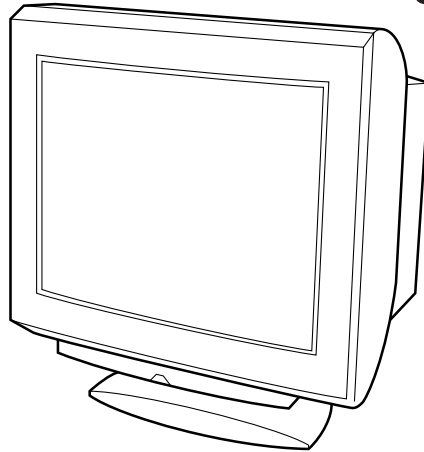

N3 CHASSIS

SPECIFICATIONS

Picture tube	0.25 – 0.27 mm aperture grille pitch 21 inches measured diagonally 90-degree deflection
Viewable image size	Approx. 403.8 × 302.2 mm (w/h) (16 × 12 inches) 19.8" viewing image measured diagonally
Resolution	Horizontal: Max. 1600 dots Vertical: Max. 1200 lines
Standard image area	Approx. 388 × 291 mm (w/h) (15 ³ / ₈ × 11 ¹ / ₂ inches) or Approx. 364 × 291 mm (w/h) (14 ³ / ₈ × 11 ¹ / ₂ inches)
Deflection frequency	Horizontal: 30 to 96 kHz Vertical: 48 to 160 Hz
AC input voltage/current	100 to 240 V, 50 – 60 Hz, 2.0 – 1.0 A
Power consumption	Max. 160 W
Dimensions	500.3 × 502.5 × 476.5 mm (w/h/d) (19 ³ / ₄ × 19 ⁷ / ₈ × 18 ⁷ / ₈ inches)
Mass	Approx. 31 kg (68 lb 5 oz)

Design and specifications are subject to change without notice.

COLOR GRAPHIC DISPLAY



SAFETY CHECK-OUT (US Model only)

After correcting the original service problem, perform the following safety checks before releasing the set to the customer:

1. Check the area of your repair for unsoldered or poorly-soldered connections. Check the entire board surface for solder splashes and bridges.
2. Check the interboard wiring to ensure that no wires are "pinched" or contact high-wattage resistors.
3. Check that all control knobs, shields, covers, ground straps, and mounting hardware have been replaced. Be absolutely certain that you have replaced all the insulators.
4. Look for unauthorized replacement parts, particularly transistors, that were installed during a previous repair. Point them out to the customer and recommend their replacement.
5. Look for parts which, though functioning, show obvious signs of deterioration. Point them out to the customer and recommend their replacement.
6. Check the line cords for cracks and abrasion. Recommend the replacement of any such line cord to the customer.
7. Check the B+ and HV to see if they are specified values. Make sure your instruments are accurate; be suspicious of your HV meter if sets always have low HV.
8. Check the antenna terminals, metal trim, "metallized" knobs, screws, and all other exposed metal parts for AC Leakage. Check leakage as described below.

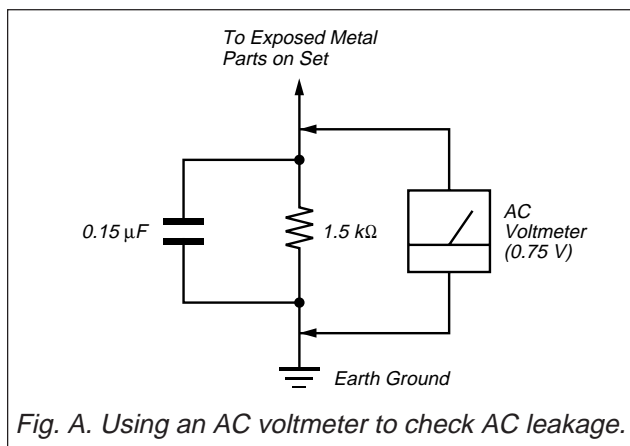

LEAKAGE TEST

The AC leakage from any exposed metal part to earth ground and from all exposed metal parts to any exposed metal part having a return to chassis, must not exceed 0.5 mA (500 microamperes).

Leakage current can be measured by any one of three methods.

1. A commercial leakage tester, such as the Simpson 229 or RCA WT-540A. Follow the manufacturers' instructions to use these instruments.
2. A battery-operated AC milliammeter. The Data Precision 245 digital multimeter is suitable for this job.
3. Measuring the voltage drop across a resistor by means of a VOM or battery-operated AC voltmeter. The "limit" indication is 0.75 V, so analog meters must have an accurate low-voltage scale. The Simpson 250 and Sanwa SH-63Trd are examples of a passive VOMs that are suitable. Nearly all battery operated digital multimeters that have a 2 V AC range are suitable. (See Fig. A)

WARNING!!

NEVER TURN ON THE POWER IN A CONDITION IN WHICH THE DEGAUSS COIL HAS BEEN REMOVED.

SAFETY-RELATED COMPONENT WARNING!!

COMPONENTS IDENTIFIED BY SHADING AND MARK \triangle ON THE SCHEMATIC DIAGRAMS, EXPLODED VIEWS AND IN THE PARTS LIST ARE CRITICAL FOR SAFE OPERATION. REPLACE THESE COMPONENTS WITH SONY PARTS WHOSE PART NUMBERS APPEAR AS SHOWN IN THIS MANUAL OR IN SUPPLEMENTS PUBLISHED BY SONY. CIRCUIT ADJUSTMENTS THAT ARE CRITICAL FOR SAFE OPERATION ARE IDENTIFIED IN THIS MANUAL. FOLLOW THESE PROCEDURES WHENEVER CRITICAL COMPONENTS ARE REPLACED OR IMPROPER OPERATION IS SUSPECTED.

AVERTISSEMENT!!

NE JAMAIS METTRE SOUS TENSION QUAND LA BOBINE DE DEMAGNETISATION EST ENLEVÉE.

ATTENTION AUX COMPOSANTS RELATIFS À LA SÉCURITÉ!!

LES COMPOSANTS IDENTIFIÉS PAR UNE TRAME ET UNE MARQUE \triangle SONT CRITIQUES POUR LA SÉCURITÉ. NE LES REMPLACER QUE PAR UNE PIÈCE PORTANT LE NUMÉRO SPECIFIÉ. LES RÉGLAGES DE CIRCUIT DONT L'IMPORTANCE EST CRITIQUE POUR LA SÉCURITÉ DU FONCTIONNEMENT SONT IDENTIFIÉS DANS LE PRÉSENT MANUEL. SUIVRE CES PROCÉDURES LORS DE CHAQUE REMPLACEMENT DE COMPOSANTS CRITIQUES, OU LORSQU'UN MAUVAIS FONCTIONNEMENT EST SUSPECTÉ.

POWER SAVING FUNCTION

This monitor meets the power-saving guidelines set by VESA and Energy Star, as well as the more stringent NUTEK .

In particular, the monitor is capable of entering a low power state when it is inactive and used with an Energy Star capable framebuffer and appropriate Sun system software.

You can set the delay time before the monitor enters the power saving mode using the OSD. Set the time according to “Setting the power saving delay time” on page 15.

Note

If no video signal is input to the monitor, the “NO INPUT SIGNAL” message (page 18) appears. After the delay time has passed, the power saving function automatically puts the monitor into the active-off mode and the  indicator lights up orange. Once the horizontal and vertical sync signals are detected, the monitor automatically resumes its normal operation mode.

	Power consumption mode	Screen	Horizontal sync signal	Vertical sync signal	Power consumption	Recovery time	 indicator
1	Normal operation	active	present	present	≤ 160 W	—	Green
2	Standby (1st mode)	blank	absent	present	≤ 100 W	Approx. 3 sec.	Green and orange alternate
3	Suspend (2nd mode)	blank	present	absent	≤ 15 W	Approx. 3 sec.	Green and orange alternate
4	Active-off (3rd mode)	blank	absent	absent	≤ 5 W	Approx. 10 sec.	Orange
5	Power-off	—	—	—	< 1.0 W	—	Off

DIAGNOSIS

Failre	Power LED
+B failure	Yellow → Off (0.5 sec) (0.5 sec)
Horizontal / Vertical Deflection failure, Thermal protector	Yellow → Off (1.5 sec) (0.5 sec)
ABL protector	Yellow → Off (0.5 sec) (1.5 sec)
HV failure	Yellow → Off → Yellow → Off (0.25 sec) (0.5 sec) (0.25 sec) (1.25 sec)
Aging / Self Test	Yellow → Off → Green → Off (0.5 sec) (0.5 sec) (0.5 sec) (0.5 sec)

Aging Mode (Video Aging) : During Power Save, press “MENU” key for longer than 2 second.

Self Test (OSD Color Bar) : During Power Save, press “CONTRAST” + (➡) key for longer than 2 second.

Reliability Check Mode : During Power Save, press “CONTRAST” – (⬅) key for longer than 2 second.

TIMING SPECIFICATION

MODE AT PRODUCTION	MODE 1	MODE 2
RESOLUTION	1280 X 1024	1152 X 900
CLOCK	135.000 MHZ	108.000 MHZ
-- HORIZONTAL --		
H-FREQ	81.130 kHz	71.809 kHz
	usec	usec
H. TOTAL	12.326	13.926
H. BLK	2.844	3.259
H. FP	0.237	0.296
H. SYNC	0.474	1.185
H. BP	2.133	1.778
H. ACTIV	9.481	10.667
-- VERTICAL --		
V. FREQ(HZ)	76.107 Hz	76.149 Hz
	lines	lines
V. TOTAL	1066	943
V. BLK	42	43
V. FP	2	2
V. SYNC	8	8
V. BP	32	33
V. ACTIV	1024	900
-- SYNC --		
INT(G)	NO	NO
EXT(H/V)/POLARITY	NO	NO
EXT(CS)/POLARITY	YES N	YES N
INT/NON INT	NON INT	NON INT

97.12.10 Ver.

TABLE OF CONTENTS

<i>Section</i>	<i>Title</i>	<i>Page</i>
1. GENERAL		1-1
2. DISASSEMBLY		
2-1.	Rear Bucket Assy Removal	2-1
2-2.	D Board Removal	2-1
2-3.	G Board Removal	2-2
2-4.	A Board Removal	2-2
2-5.	L Board Removal	2-3
2-6.	I/O Terminal Board Assy Removal	2-3
2-7.	Service Position	2-4
2-8.	H1, H2 and J Boards Removal	2-4
2-9.	Picture Tube Removal	2-5
3. SAFETY RELATED ADJUSTMENT		3-1
4. ADJUSTMENTS		4-1
5. DIAGRAMS		
5-1.	Block Diagrams	5-1
5-2.	Frame Schematic Diagram	5-7
5-3.	Circuit Boards Location	5-9
5-4.	Schematic Diagrams and Printed Wiring Boards	5-9
(1)	Schematic Diagram of D Board	5-13
(2)	Schematic Diagrams of G, GA, H1, H2, J and L Boards	5-17
(3)	Schematic Diagram of A Board	5-24
5-5.	Semiconductors	5-29
6. EXPLODED VIEWS		
6-1.	Chassis	6-1
6-2.	Picture Tube	6-2
6-3.	Packing Materials	6-3
7. ELECTRICAL PARTS LIST		7-1

Note: Hand degauss must be used on stand-by or power-off condition.

This model has an automatic earth magnetism correction function by using an earth magnetism sensor and a LCC coil. When using a hand degauss while monitor (LCC coil) is being operated, it sometimes gets magnetized, and the system may not work properly as a result.

The operating instructions mentioned here are partial abstracts from the Operating Instruction Manual. The page numbers of the Operating Instruction Manual remain as in the manual.

SECTION 1 GENERAL

Getting Started

Identifying Parts and Controls

See the pages in parentheses for further details.

Front

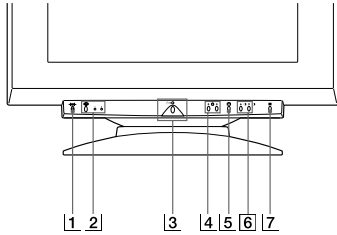

- 1 (reset) button (page 16)
Resets the adjustments to the factory settings.
- 2 (input) button and 1 (13W3) / 2 (HD15) indicators (pages 7 - 8)
Selects the 1 (13W3) or 2 (HD15) video input signal. Each time you press this button, the input signal and corresponding indicator alternate.
- 3 (power) switch and indicator (pages 17, 20)
Turns the monitor on or off. The indicator lights up in green when the monitor is turned on, and lights up in orange when the monitor is in power saving mode.
- 4 (brightness) (↑/↓) buttons (pages 8 - 16)
Adjust the picture brightness. Function as the (↑/↓) buttons when adjusting other items.
- 5 (menu) button (pages 7, 9 -16)
Displays the MENU OSD.
- 6 (contrast) (←/→) buttons (pages 8 - 16, 20)
Adjust the contrast. Function as the (←/→) buttons when adjusting other items.
- 7 (auto sizing and centering) button (page 7)
Automatically adjusts the size and centering of the images.

Rear

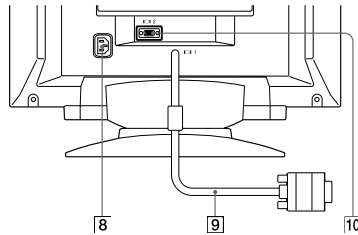

- 8 **AC IN connector**
Provides AC power to the monitor.
- 9 **Video input 1 connector (13W3 cable)**
Inputs RGB video signal (0.700 Vp-p, positive).

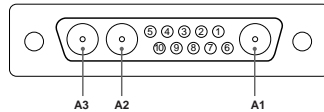

Pin No.	Signal	Pin No.	Signal
A1	Red	5	C.Sync*
A2	Green	6	Bi-Directional Data (SDA)**
A3	Blue	7	V.Sync
1	Data Clock (SCL)**	8	ID (100 Ω)
2	DDC + 5V**	9	ID (100 Ω)
3	—	10	Ground
4	DDC Ground**		

* Pins serve a dual purpose as combined sync input and as H.sync input if V.Sync is present on pin no. 7.
** Display Data Channel (DDC) Standard by VESA

Note

If you use a computer or video board of high output level (about 1.0 Vp-p), you may not be able to obtain the optimum display. In such case, try decreasing the picture contrast, or use a computer or video board with a lower output level.

(continued)

Getting Started

- 10 **Video input 2 connector (HD15)**
Inputs RGB video signals (0.700 Vp-p, positive) and SYNC signals.



Pin No.	Signal	Pin No.	Signal
1	Red	8	Blue Ground
2	Green (Composite Sync on Green)	9	DDC + 5V*
		10	Ground
		11	—
3	Blue	12	Bi-Directional Data (SDA)*
4	—		
5	DDC Ground*	13	H. Sync
6	Red Ground	14	V. Sync
7	Green Ground	15	Data Clock(SCL)*

* Display Data Channel (DDC) Standard of VESA

Setup

Before using this monitor, check that the following items are included in your carton:

- Monitor (1)
- These operating instructions (1)

Step 1: Connect the monitor to the computer

With the computer switched off, connect the video signal cable to the video output of the computer.

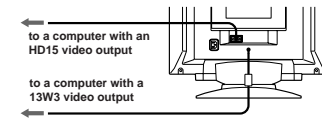

Note

Do not short the pins of the video signal cable.

Step 2: Connect the power cord

With the monitor switched off, connect one end of the proper power cord for your local supply to the monitor and the other end to a power outlet.

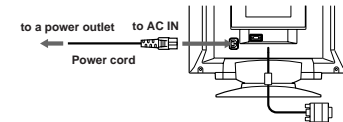

Step 3: Turn on the monitor and computer

The installation of your monitor is complete.

Note

If "OUT OF SCAN RANGE" or "NO INPUT SIGNAL" appears on the screen, see "Warning Messages" on page 18.

Getting Started

Automatically Adjusting the Size and Centering of the Picture

By pressing the auto sizing and centering () button, the size and centering of the picture are automatically adjusted to fit the screen.

1 Turn on the monitor and computer.

2 Press the  button.

The picture is adjusted to fit the center of the screen.

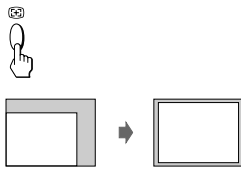

Notes

- This function may not work properly if the background color is dark or if the input picture does not fill the screen to the edges.
- The screen may go blank for a few seconds while performing the auto-sizing function. This is not a malfunction.
- Although the signals for picture aspect ratio 5:4 (resolution: 1280 × 1024) do not fill the screen to the edges, the picture is accurately displayed.

Selecting the On-screen Display Language

If you need to change the OSD language, see "Using the LANG (Language) On-screen Display" on page 16. The default setting is English.

Selecting the Input Signal

This monitor has two signal input connectors (13W3 pigtail cable and HD15 connector) and can be connected to two computers. When the power of both computers is on, select the input signal you want to view as follows.

1 Turn on the monitor and both computers.

2 Press the  button to select 1 (13W3) or 2 (HD15) input signal.

Each time you press the  button, the input signal and corresponding indicator alternate.



Selecting the INPUT signal mode

This monitor has two modes of input signal selection, "AUTO" and "MANUAL."

When "AUTO" is selected

If no signal is input from the selected connector, the monitor automatically selects the other connector's signal. When you restart the computer you want to view, or that computer is in power saving mode, the monitor may automatically select the other connector's signal. This is because the monitor switches from the interrupted signal to the constant signal. If this happens, manually select the desired signal using the  button.

When "MANUAL" is selected



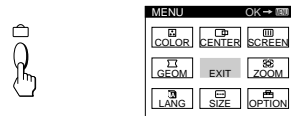

Even if no signal is input from the selected connector, the monitor does not select the other connector's signal.

1 Press the  button.
The MENU OSD appears.



(continued)

Getting Started

2 Press the  and  buttons to select "  OPTION," and press the  button again.
The OPTION OSD appears.

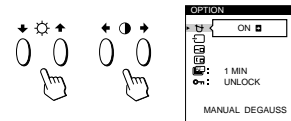

3 Press the  buttons to select "  (INPUT)."

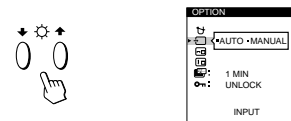

4 Press the  buttons to select "AUTO" or "MANUAL."



The OPTION OSD automatically disappears after about 30 seconds.

To close the OSD, press the  button again.

For more information on using the OSD, see "Introducing the On-screen Display System" on page 9.



Customizing Your Monitor

Before adjusting

- Connect the monitor and the computer, and turn them on.
- Select "  LANG" in the MENU OSD, then select "ENGLISH" (see page 16).

Adjusting the Picture Brightness and Contrast

Once the setting is adjusted, it will be stored in memory for all input signals received.

1 Press the  (brightness)  or  (contrast)  buttons.

The BRIGHTNESS/CONTRAST OSD appears.

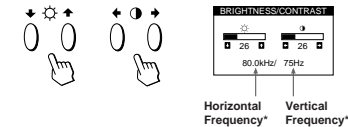

2 For brightness adjustment

Press the  buttons.

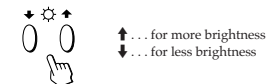

For contrast adjustment

Press the  buttons.

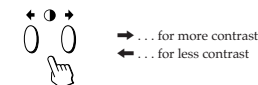

The OSD automatically disappears after about 3 seconds.

To reset, press the  (reset) button while the OSD is on. The brightness and contrast are both reset to the factory settings.

* The horizontal and vertical frequencies for the received input signal appear in the BRIGHTNESS/CONTRAST OSD.

Introducing the On-screen Display System

Most adjustments are made using the MENU OSD.

MENU OSD

Press the button to display the MENU OSD. This MENU OSD contains links to the other OSDs described below.

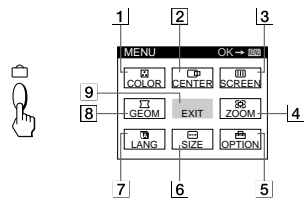

- 1 **COLOR**
Displays the COLOR OSD for adjusting the color temperature.
- 2 **CENTER**
Displays the CENTER OSD for adjusting the centering of the picture.
- 3 **SCREEN**
Displays the SCREEN OSD for adjusting the vertical and horizontal convergence, etc.
- 4 **ZOOM**
Displays the ZOOM OSD for enlarging and reducing the picture.
- 5 **OPTION**
Displays the OPTION OSD for adjusting the OSD position and degaussing the screen, etc.
- 6 **SIZE**
Displays the SIZE OSD for adjusting the picture size.
- 7 **LANG**
Displays the LANGUAGE OSD for selecting the language.
- 8 **GEOM**
Displays the GEOMETRY OSD for adjusting the picture rotation and pincushion, etc.
- 9 **EXIT**
Closes the MENU OSD.

Using the CENTER On-screen Display

The CENTER settings allow you to adjust the centering of the picture. Once the setting is adjusted, it will be stored in memory for the current input signal.

- 1 Press the button.
The MENU OSD appears.
- 2 Press the and buttons to select " CENTER," and press the button again.
The CENTER OSD appears.

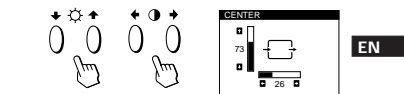

- 3 For horizontal adjustment
Press the buttons.
 ... to move the picture right
 ... to move the picture left
- For vertical adjustment
Press the buttons.
 ... to move the picture up
 ... to move the picture down

The OSD automatically disappears after about 30 seconds. To close the OSD, press the button again.

To reset, press the (reset) button while the OSD is on. The horizontal and vertical centerings are both reset to the factory settings.

Using the SIZE On-screen Display

The SIZE settings allow you to adjust the size of the picture. Once the setting is adjusted, it will be stored in memory for the current input signal.

- 1 Press the button.
The MENU OSD appears.
- 2 Press the and buttons to select " SIZE," and press the button again.
The SIZE OSD appears.

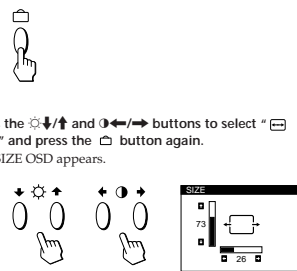

- 3 For horizontal adjustment
Press the buttons.
 ... to increase picture size
 ... to decrease picture size
- For vertical adjustment
Press the buttons.
 ... to increase picture size
 ... to decrease picture size

The OSD automatically disappears after about 30 seconds. To close the OSD, press the button again.

To reset, press the (reset) button while the OSD is on. The horizontal and vertical sizes are both reset to the factory settings.

Using the GEOM (Geometry) On-screen Display

The GEOM (geometry) settings allow you to adjust the shape and orientation of the picture. Once the rotation is adjusted, it will be stored in memory for all input signals received. All other adjustments will be stored in memory for the current input signal.

- 1 Press the button.
The MENU OSD appears.
- 2 Press the and buttons to select " GEOM," and press the button again.
The GEOMETRY OSD appears.

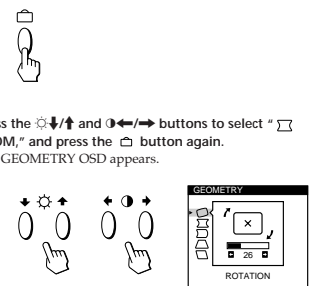











- 3 Press the buttons to select the item you want to adjust.

Select	To
	adjust the picture rotation
	adjust the picture sides
	adjust the picture side balance
	adjust the picture width at the top
	adjust the picture shape balance

4 Press the \leftarrow/\rightarrow buttons to adjust the settings.



For	Press
<input type="checkbox"/> ROTATION	→ ... to rotate the picture clockwise  ← ... to rotate the picture counterclockwise 
<input type="checkbox"/> PINCUSHION	→ ... to expand the picture sides  ← ... to contract the picture sides 
<input type="checkbox"/> PIN BALANCE	→ ... to move the picture sides to the right  ← ... to move the picture sides to the left 
<input type="checkbox"/> KEYSTONE	→ ... to increase the picture width at the top  ← ... to decrease the picture width at the top 
<input type="checkbox"/> KEY BALANCE	→ ... to move the top of the picture to the right  ← ... to move the top of the picture to the left 

The OSD automatically disappears after about 30 seconds. To close the OSD, press the \square button again.

To reset, press the $\rightarrow\leftarrow$ (reset) button while the OSD is on. The selected item is reset to the factory setting.

Using the ZOOM On-screen Display

The ZOOM settings allow you to enlarge or reduce the picture. Once the setting is adjusted, it will be stored in memory for the current input signal.

1 Press the \square button. The MENU OSD appears.



2 Press the \uparrow/\downarrow and \leftarrow/\rightarrow buttons to select "ZOOM," and press the \square button again. The ZOOM OSD appears.

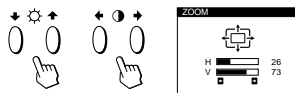

3 Press the \leftarrow/\rightarrow buttons to adjust the picture zoom.

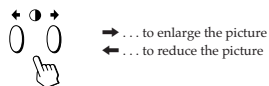

The OSD automatically disappears after about 30 seconds. To close the OSD, press the \square button again.

To reset, press the $\rightarrow\leftarrow$ (reset) button while the OSD is on.

Note
The picture zoom adjustment will stop as soon as either the horizontal or vertical size reaches its maximum or minimum value.

Using the COLOR On-screen Display

You can change the monitor's color temperature. For example, you can adjust or change the colors of a picture on the screen to match the actual colors of the printed picture. Once the setting is adjusted, it will be stored in memory for all input signals received.

1 Press the \square button. The MENU OSD appears.



2 Press the \uparrow/\downarrow and \leftarrow/\rightarrow buttons to select "COLOR," and press the \square button again. The COLOR OSD appears.

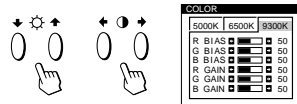

3 Press the \leftarrow/\rightarrow buttons to select the color temperature.

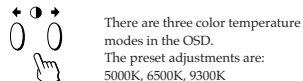

There are three color temperature modes in the OSD. The preset adjustments are: 5000K, 6500K, 9300K

4 Fine tuning the color temperature
Press the \uparrow/\downarrow buttons to select an item and adjust by pressing the \leftarrow/\rightarrow buttons.

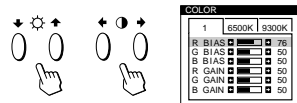

Select R (red), G (green), or B (blue) BIAS to adjust the black level of each color's signal.

Select R (red), G (green), or B (blue) GAIN to adjust the white level of each color's signal.

The "5000K," "6500K" or "9300K" disappears and the new color settings are memorized for each of the three color modes. The color temperature modes change as follows: 5000K → 1, 6500K → 2, 9300K → 3

The OSD automatically disappears after about 30 seconds. To close the OSD, press the \square button again.

To reset, press the $\rightarrow\leftarrow$ (reset) button while the OSD is on. The selected item is reset to the factory settings.

Using the SCREEN On-screen Display

You can adjust convergence settings to eliminate red or blue shadows that may appear around objects on the screen. Adjust the CANCEL MOIRE function to eliminate wavy or elliptical patterns that may appear on the screen.

Adjust the LANDING function to correct color imbalances at the four corners of the screen due to influence from the earth's magnetism.

Once CANCEL MOIRE is adjusted, it will be stored in memory for the current input signal. All other adjustments will be stored in memory for all input signals received.

1 Press the \square button. The MENU OSD appears.



2 Press the \uparrow/\downarrow and \leftarrow/\rightarrow buttons to select "SCREEN," and press the \square button again. The SCREEN OSD appears.

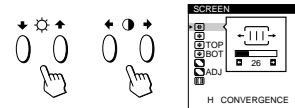

3 Press the \uparrow/\downarrow buttons to select the item you want to adjust.



Select	To
\rightarrow H CONVERGENCE	adjust the horizontal convergence
\uparrow V CONVERGENCE	adjust the vertical convergence
\uparrow TOP V CONVER TOP	adjust the screen's upper vertical convergence
\downarrow BOT V CONVER BOTTOM	adjust the screen's lower vertical convergence

Customizing Your Monitor

Select	To
LANDING	select one of the four corners that needs color correction due to influence from the earth's magnetism
LANDING ADJUST	correct the color at one of the four corners of the screen
CANCEL MOIRE *	turn the moire cancellation function "ON" or "OFF." CANCEL MOIRE must be "ON" for " ADJ (MOIRE ADJUST)" to appear on the screen.
MOIRE ADJUST	adjust the degree of moire cancellation

* Moire is a type of natural interference which produces soft or wavy lines on your screen. It may appear due to interference between the regulated pattern of the picture from the input signal and the phosphor pitch pattern of the CRT.

Example of moire:



4 Press the buttons to adjust the settings.



For	Press
H CONVERGENCE	→ ... to shift red shadows to the right and blue shadows to the left ← ... to shift red shadows to the left and blue shadows to the right
V CONVERGENCE	→ ... to shift red shadows up and blue shadows down ← ... to shift red shadows down and blue shadows up
TOP V CONVER TOP	→ ... to shift red shadows up and blue shadows down ← ... to shift red shadows down and blue shadows up

For	Press
BOT V CONVER BOTTOM	→ or ... to shift red shadows up and blue shadows down ← ... to shift red shadows down and blue shadows up
LANDING	→ or ← ... to select the corner of the screen you want to adjust : top left : top right : bottom left : bottom right
ADJ LANDING ADJUST	→ or ← ... to reduce any irregularities in the color to a minimum
CANCEL MOIRE	→ ... to turn CANCEL MOIRE "ON" <OFF >ON ← ... to turn CANCEL MOIRE "OFF" <OFF >ON
ADJ MOIRE ADJUST	→ or ← ... to adjust the screen until the moire is at a minimum

Note

The picture may become fuzzy when CANCEL MOIRE is set to "ON."

The OSD automatically disappears after about 30 seconds. To close the OSD, press the button again.

To reset, press the (reset) button while the OSD is on. The selected item is reset to the factory setting.

EN

Customizing Your Monitor

Using the OPTION On-screen Display

The OPTION OSD allows you to manually degauss the screen and adjust settings such as the OSD position and power saving delay time. It also allows you to lock the controls.

Degaussing the screen

The monitor screen is automatically degaussed (demagnetized) when the power is turned on. You can also manually degauss the monitor.

1 Press the button.

The MENU OSD appears.



2 Press the and buttons to select "OPTION," and press the button again.

The OPTION OSD appears.

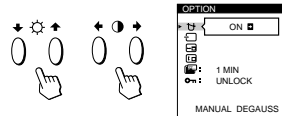

3 Press the buttons to select "MANUAL DEGAUSS."



4 Press the button.

The screen is degaussed for about 3 seconds.



If you need to degauss the screen a second time, wait for at least 20 minutes before repeating the steps above.

The OPTION OSD automatically disappears after about 30 seconds.

To close the OSD, press the button again.

Changing the on-screen display position

You can change the OSD position (for example, when you want to adjust the picture behind the OSD).

1 Press the button.

The MENU OSD appears.



2 Press the and buttons to select "OPTION," and press the button again.

The OPTION OSD appears.

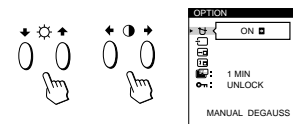

3 Press the buttons to select "OSD H POSITION)" or "OSD V POSITION)."

Select "OSD H POSITION)" to adjust the horizontal position.



Select "OSD V POSITION)" to adjust the vertical position.

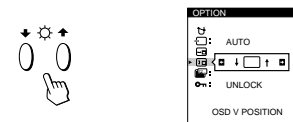

4 Press the buttons to move the OSD to the desired position.



The OPTION OSD automatically disappears after about 30 seconds.

To close the OSD, press the button again.

To reset, press the (reset) button while the OSD is on.



Customizing Your Monitor

Setting the powersaving delay time



You can set the delay time before the monitor enters the power saving mode. See page 17 for more information on this monitor's power saving capabilities.

- 1 Press the  button.
The MENU OSD appears.

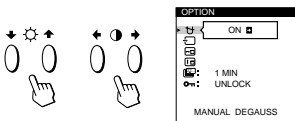

- 2 Press the  and  buttons to select "OPTION," and press the  button again.
The OPTION OSD appears.



- 3 Press the  and  buttons to select "PWR SAVE DELAY."

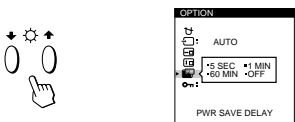

- 4 Press the  and  buttons to select the desired time.





When PWR SAVE DELAY is set to "OFF," the monitor does not go into power saving mode.

The OPTION OSD automatically disappears after about 30 seconds.

To close the OSD, press the  button again.



To reset, press the  (reset) button while the OSD is on.

Locking the controls



The control lock function disables all of the buttons on the front panel except the  (power) switch,  and  buttons.

- 1 Press the  button.
The MENU OSD appears.



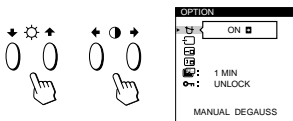

- 2 Press the  and  buttons to select "OPTION," and press the  button again.
The OPTION OSD appears.

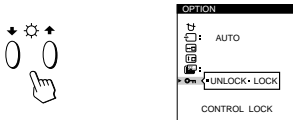

- 3 Press the  and  buttons to select "CONTROL LOCK."







- 4 Press the  and  buttons to select "LOCK."





The OPTION OSD automatically disappears after about 30 seconds.

To close the OSD, press the  button again.

Once you select "LOCK," you cannot select any items except "EXIT" and "OPTION" in the MENU OSD. If you press any button other than the  (power) switch,  and  buttons, the  mark appears on the screen.

To cancel the control lock

Repeat steps 1 through 3 above and press the  and  buttons to select "UNLOCK."



Customizing Your Monitor

Using the LANG (Language) On-screen Display



English, French, German, Spanish, Italian and Japanese versions of the OSDs are available.

- 1 Press the  button.
The MENU OSD appears.

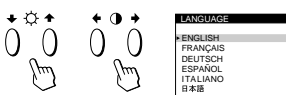

- 2 Press the  and  buttons to select "LANG," and press the  button again.
The LANGUAGE OSD appears.



- 3 Press the  and  buttons to select the desired language.





ENGLISH: English, FRANÇAIS: French, DEUTSCH: German, ESPAÑOL: Spanish, ITALIANO: Italian, or 日本語: Japanese.

The OSD automatically disappears after about 30 seconds. To close the OSD, press the  button again.



To reset to English, press the  (reset) button while the OSD is on.

Resetting the Adjustments

Resetting an adjustment item

- 1 Press the  ,  and  buttons to select the OSD containing the item you want to reset.



- 2 Press the  and  buttons to select the item you want to reset.



- 3 Press the  (reset) button.



Resetting all of the adjustment data for the current input signal

When there is no OSD displayed, press the  (reset) button.

All of the adjustments data for the current input signal is reset to the factory settings.

Note that adjustment data not affected by changes in input signal (OSD language, OSD position, input signal selection, power saving delay time and the control lock function) is not reset to the factory settings.



Resetting all of the adjustment data for all input signals

Press and hold the  (reset) button for more than two seconds.

All of the adjustment data, including the brightness and contrast, is reset to the factory settings.



Technical Features

Power Saving Function

This monitor meets the power-saving guidelines set by VESA and Energy Star, as well as the more stringent NUTEK.

In particular, the monitor is capable of entering a low power state when it is inactive and used with an Energy Star capable framebuffer and appropriate Sun system software.

You can set the delay time before the monitor enters the power saving mode using the OSD. Set the time according to "Setting the power saving delay time" on page 15.

Note

If no video signal is input to the monitor, the "NO INPUT SIGNAL" message (page 18) appears. After the delay time has passed, the power saving function automatically puts the monitor into the active-off mode and the \odot indicator lights up orange. Once the horizontal and vertical sync signals are detected, the monitor automatically resumes its normal operation mode.

	Power consumption mode	Screen	Horizontal sync signal	Vertical sync signal	Power consumption	Recovery time	\odot indicator
1	Normal operation	active	present	present	≤ 160 W	—	Green
2	Standby (1st mode)	blank	absent	present	≤ 100 W	Approx. 3 sec.	Green and orange alternate
3	Suspend (2nd mode)	blank	present	absent	≤ 15 W	Approx. 3 sec.	Green and orange alternate
4	Active-off (3rd mode)	blank	absent	absent	≤ 5 W	Approx. 10 sec.	Orange
5	Power-off	—	—	—	< 1.0 W	—	Off

Preset Modes

Mode	Resolution (dots \times lines)	Horizontal Frequency	Vertical Frequency
1	1280 \times 1024	81.1 kHz	76Hz
2	1152 \times 900	71.8 kHz	76Hz

Damper Wires

When viewing a white background, very thin horizontal lines may be visible on the screen as shown below. These lines are the shadows of the damper wires and are characteristic of CRTs that use aperture grilles. The wires are attached to the aperture grille on the inside of the Trinitron tube and prevent the vibration of the aperture grille.

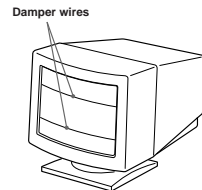

Plug & Play

This monitor complies with the DDC™1, DDC2B, DDC2AB and DDC2B+ Display Data Channel (DDC) standards of VESA.

When a DDC1 host system is connected, the monitor synchronizes with the V. CLK in accordance with the VESA standards and outputs the EDID (Extended Display Identification Data) to the data line.

When a DDC2B, DDC2AB or DDC2B+ host system is connected, the monitor automatically switches to the appropriate standard.

DDC™ is a trademark of the Video Electronics Standard Association.

EN

Additional Information

Warning Messages

If there is something wrong with the input signal, one of the following messages appears.

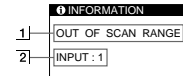

1 The input signal condition

"OUT OF SCAN RANGE" indicates that the input signal is not supported by the monitor's specifications.

"NO INPUT SIGNAL" indicates that no signal is input, or the input signal from the selected input connector is not received.

2 The selected input connector

Indicates which input connector is receiving the wrong signal. If there is something wrong with the signal from both input connectors, "1" (13W3) and "2" (HD15) are displayed alternately.

To solve these problems, see "Troubleshooting" below.

Troubleshooting

This section may help you isolate the cause of a problem and as a result, eliminate the need to contact technical support.

Symptom	Check these items
No picture	
If the \odot indicator is not lit	<ul style="list-style-type: none"> Check that the power cord is properly connected. Check that the \odot (power) switch is in the "on" position.
If the "NO INPUT SIGNAL" message appears on the screen, or if the \odot indicator is either orange or alternating between green and orange	<ul style="list-style-type: none"> The screen is blank when the monitor is in power saving mode. Try pressing any key on the computer keyboard. Check that your computer power switch is in the "on" position. Check that the input select setting is correct. Check that the video signal cable is properly connected and all plugs are firmly seated in their sockets. Ensure that no pins are bent or pushed in the 13W3 video input cable. Check that the video board is completely seated in the proper bus slot.
If the "OUT OF SCAN RANGE" message appears on the screen	<ul style="list-style-type: none"> Check that the video frequency range is within that specified for the monitor. (Horizontal: 30 - 96 kHz, Vertical: 48 - 160 Hz) Refer to your computer's instruction manual to adjust the video frequency range.
If no message is displayed and the \odot indicator is green or flashing orange	<ul style="list-style-type: none"> See "Self-diagnosis Function" (page 20).
Picture is scrambled	<ul style="list-style-type: none"> Check your graphics board manual for the proper monitor setting. Check this manual and confirm that the graphics mode and the frequency you are trying to operate at is supported. Even if the frequency is within the proper range, some video boards may have a sync pulse that is too narrow for the monitor to sync correctly.
Color is not uniform	<ul style="list-style-type: none"> Degauss the monitor (page 14). If you place equipment which generates a magnetic field, such as a loudspeaker, near the monitor, or you change the direction of the monitor, color may lose uniformity. The degauss function demagnetizes the metal frame of the CRT to obtain a neutral field for uniform color reproduction. If a second degauss cycle is needed, allow a minimum interval of 20 minutes for the best result. Adjust the landing (pages 12 - 13).

Additional Information

Symptom	Check these items
You cannot adjust the monitor with the buttons on the front panel	<ul style="list-style-type: none"> If the control lock function is set to on, set it to off using the OPTION OSD (page 15).
White does not look white	<ul style="list-style-type: none"> Adjust the color temperature (page 12).
Screen image is not centered or sized properly	<ul style="list-style-type: none"> Press the  button (page 7). Adjust the size or centering (pages 9 – 10).
Edges of the image are curved	<ul style="list-style-type: none"> Adjust the geometry (pages 10 – 11).
White lines show red or blue shadows at edges	<ul style="list-style-type: none"> Adjust the convergence (pages 12 – 13).
Picture is fuzzy	<ul style="list-style-type: none"> Adjust the contrast and brightness (page 8). Degauss the monitor (page 14). If you place equipment which generates a magnetic field, such as a loudspeaker, near the monitor, or you change the direction of the monitor, color may lose uniformity. The degauss function demagnetizes the metal frame of the CRT to obtain a neutral field for uniform color reproduction. If a second degauss cycle is needed, allow a minimum interval of 20 minutes for the best result. If red or blue shadows appear along the edges of images, adjust the convergence (pages 12 – 13). If the moire is cancelled, the picture may become fuzzy. Decrease the moire cancellation effect (pages 12 – 13).
Picture bounces or has wavy oscillations	<ul style="list-style-type: none"> Isolate and eliminate any potential sources of electric or magnetic fields. Common causes for this symptom are electric fans, fluorescent lighting or laser printers. If you have another monitor close to this monitor, increase the distance between them to reduce the interference. Try plugging the monitor into a different AC outlet, preferably on a different circuit. Try the monitor on a different computer in a different room.
Picture is flickering	<ul style="list-style-type: none"> Set the refresh rate on the computer to obtain the best possible picture by referring to the computer's manual.
Picture appears to be ghosting	<ul style="list-style-type: none"> Eliminate the use of video cable extensions and/or video switch boxes if this symptom occurs. Excessive cable length or a weak connection can produce this symptom.
Wavy or elliptical (moire) pattern is visible	<ul style="list-style-type: none"> Cancel the moire (pages 12 – 13). The moire may be modified depending on the connected computer. Due to the relationship between resolution, monitor dot pitch and the pitch of some image patterns, certain screen backgrounds sometimes show moire. Change your desktop pattern.
Two fine horizontal lines (wires) are visible	<ul style="list-style-type: none"> These wires stabilize the vertically striped aperture grille (page 17). This aperture grille allows more light to pass through to the screen giving the Trinitron CRT more color and brightness.
Hum is heard right after the power is turned on	<ul style="list-style-type: none"> When the power is turned on, the auto-degauss cycle is activated. While the auto-degauss cycle is activated (3 seconds), a hum may be heard. The same hum is heard when the monitor is manually degaussed. This is not a malfunction.

EN

Additional Information

Self-diagnosis Function

This monitor is equipped with a self-diagnosis function. If there is a problem with your monitor or computer(s), the screen will go blank and the  indicator will either light up green or flash orange.

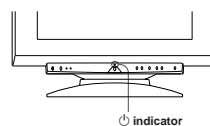

If the indicator is green

- 1 Disconnect video input 1 and 2, or turn off the connected computer(s).
- 2 Press and hold the  button for 2 seconds.





If all four color bars appear (white, red, green, blue), the monitor is working properly. Reconnect the video input cables and check the condition of your computer(s).

If the color bars do not appear, there is a potential monitor failure. Inform your authorized Sun dealer of the monitor's condition.

If the indicator is flashing orange

Press the  button to turn the monitor off and on.

If the  indicator lights up green, the monitor is working properly.

If the  indicator is still flashing, there is a potential monitor failure. Count the number of seconds between orange flashes of the  indicator and inform your authorized Sun dealer of the monitor's condition. Be sure to note the model name and serial number of your monitor. Also note the make and model of your computer and video board.

Specifications

Picture tube	0.25 – 0.27 mm aperture grille pitch 21 inches measured diagonally 90-degree deflection
Viewable image size	Approx. 403.8 × 302.2 mm (w/h) (16 × 12 inches) 19.8" viewing image measured diagonally
Resolution	Horizontal: Max. 1600 dots Vertical: Max. 1200 lines
Standard image area	Approx. 388 × 291 mm (w/h) (15 ³ / ₈ × 11 ¹ / ₂ inches) or Approx. 364 × 291 mm (w/h) (14 ³ / ₈ × 11 ¹ / ₂ inches)
Deflection frequency	Horizontal: 30 to 96 kHz Vertical: 48 to 160 Hz
AC input voltage / current	100 to 240 V, 50 – 60 Hz, 2.0 – 1.0 A
Power consumption	Max. 160 W
Dimensions	500.3 × 502.5 × 476.5 mm (w/h/d) (19 ³ / ₄ × 19 ⁷ / ₈ × 18 ⁷ / ₈ inches)
Mass	Approx. 31 kg (68 lb 5 oz)

Design and specifications are subject to change without notice.

SECTION 2 DISASSEMBLY

2-1. REAR BUCKET ASSY REMOVAL

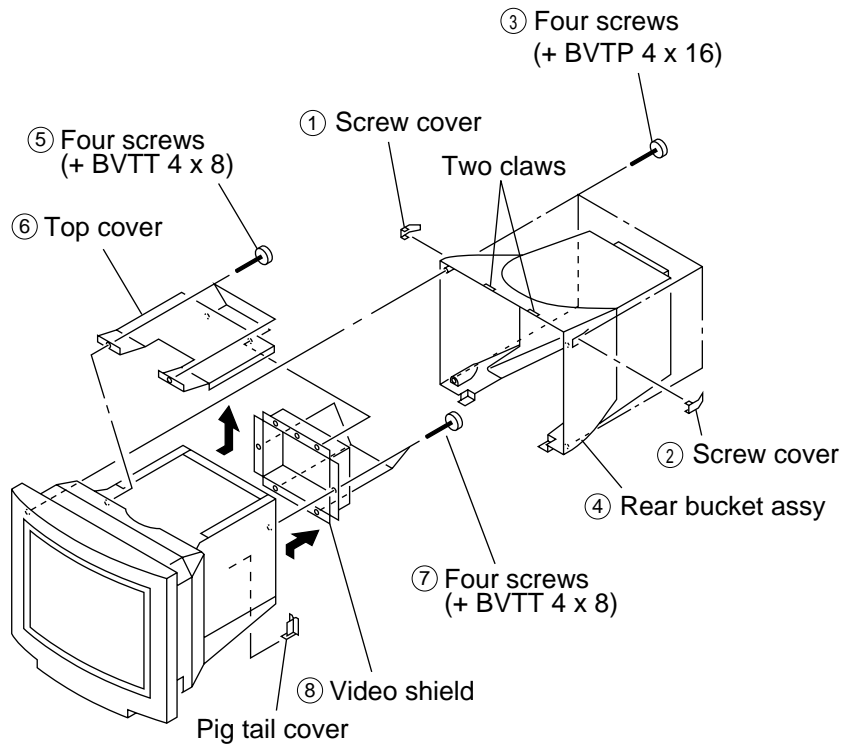

2-2. D BOARD REMOVAL

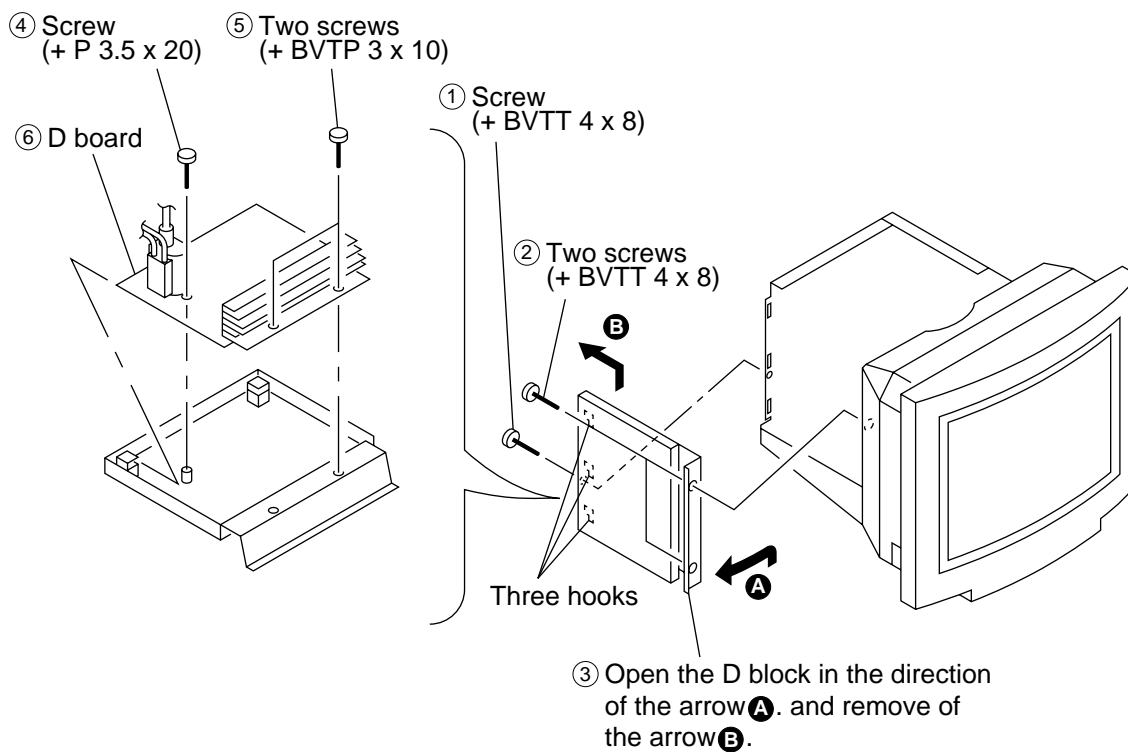

2-3. G BOARD REMOVAL

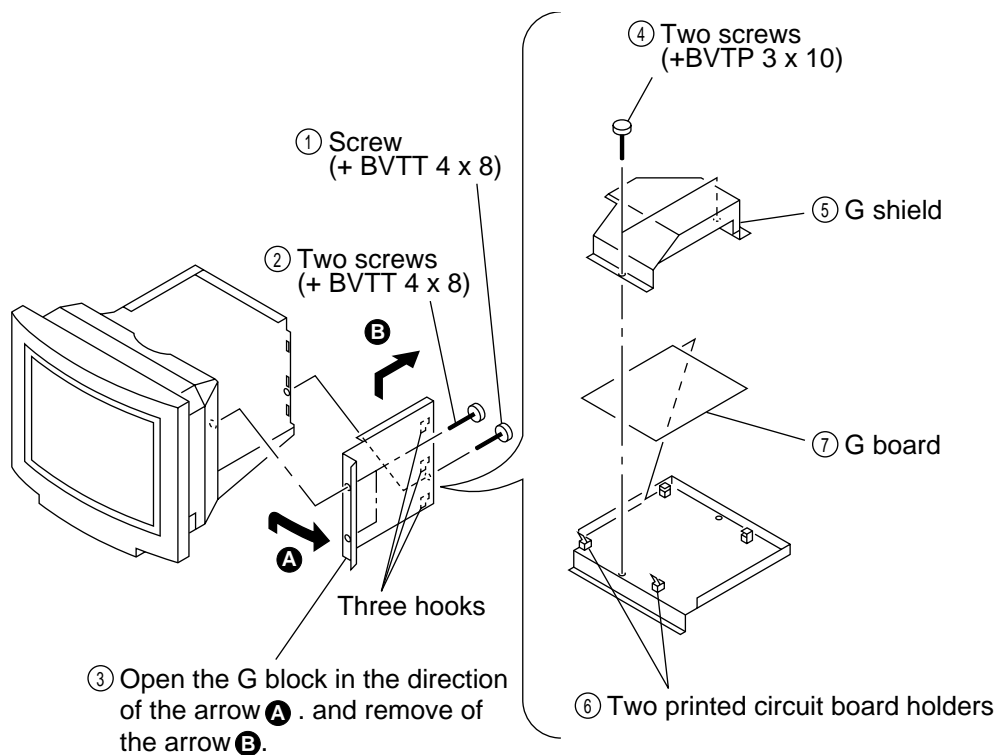

2-4. A BOARD REMOVAL

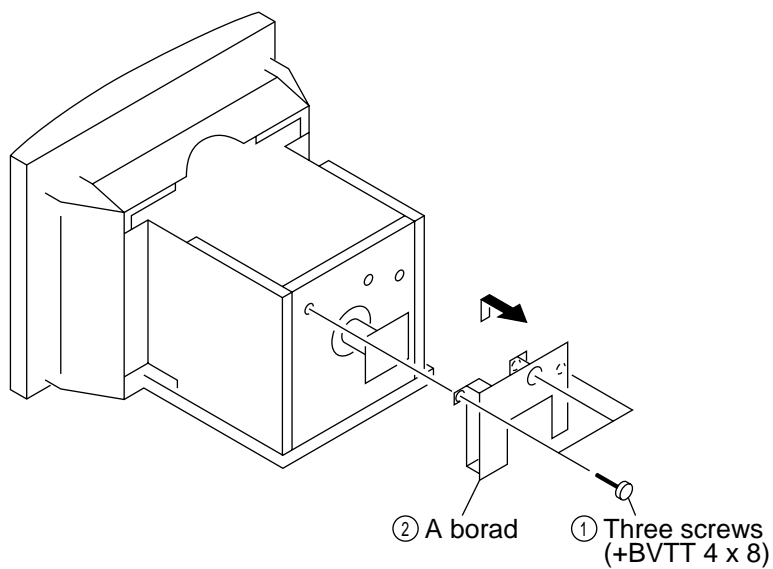

2-5. L BOARD REMOVAL

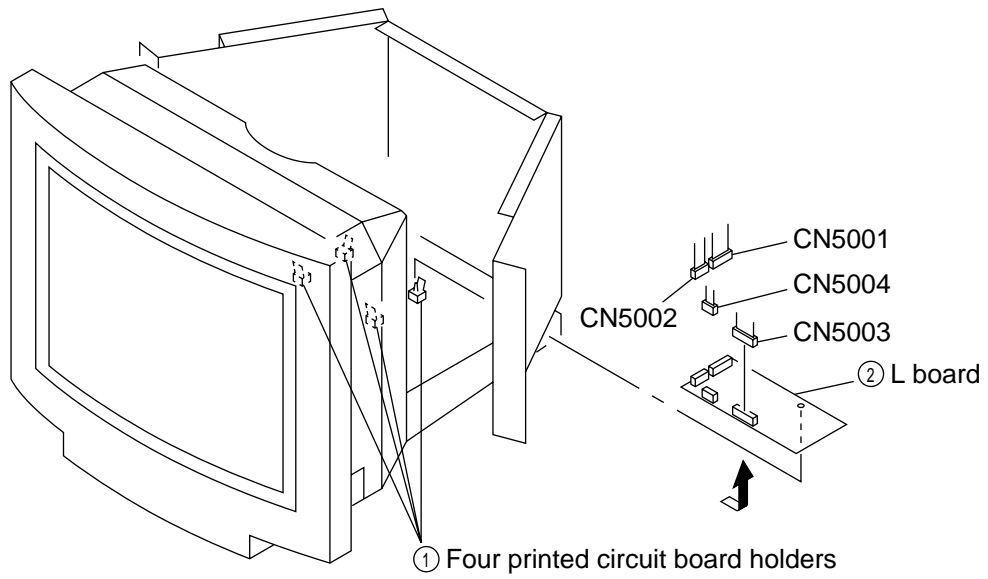

2-6. I/O TERMINAL BOARD ASSY REMOVAL

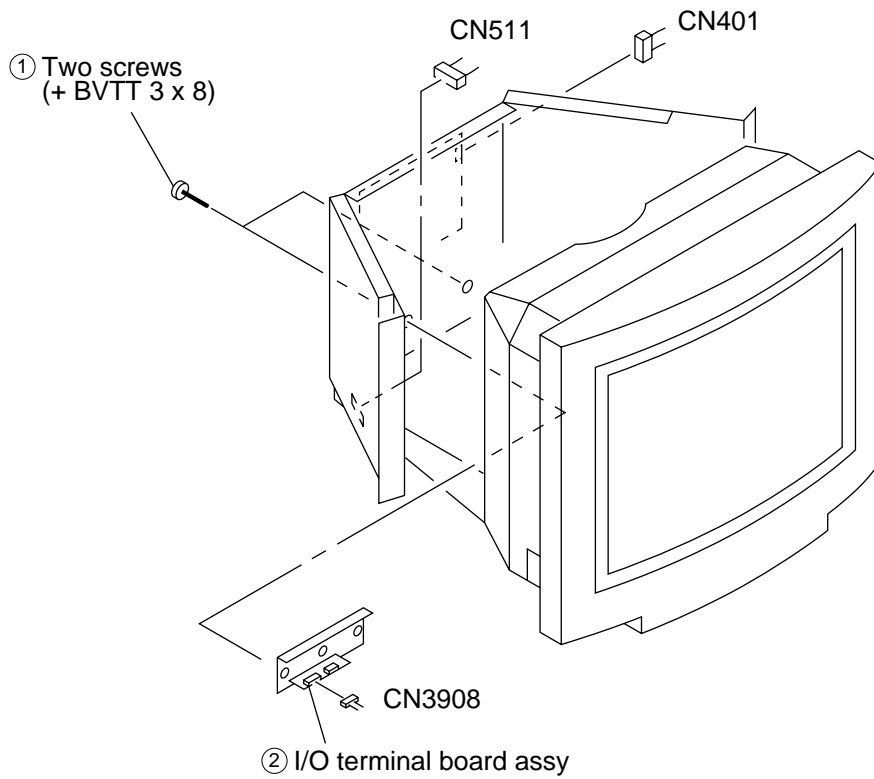

2-7. SERVICE POSITION

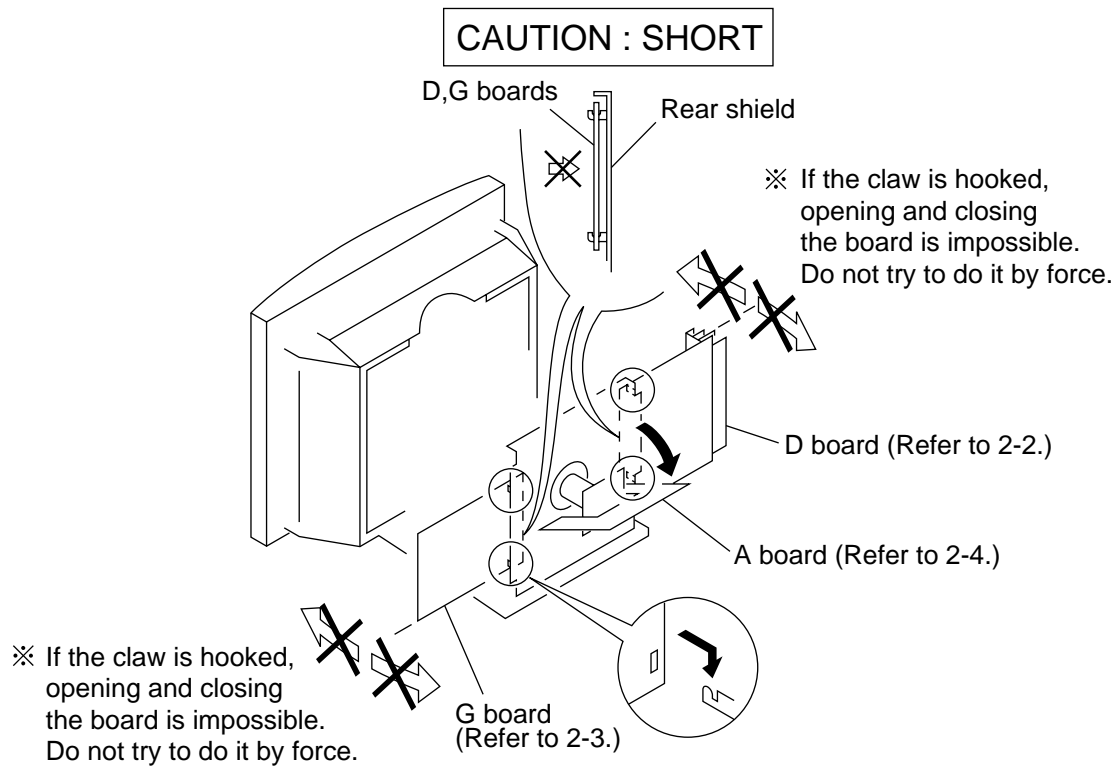

2-8. H1, H2 AND J BOARDS REMOVAL

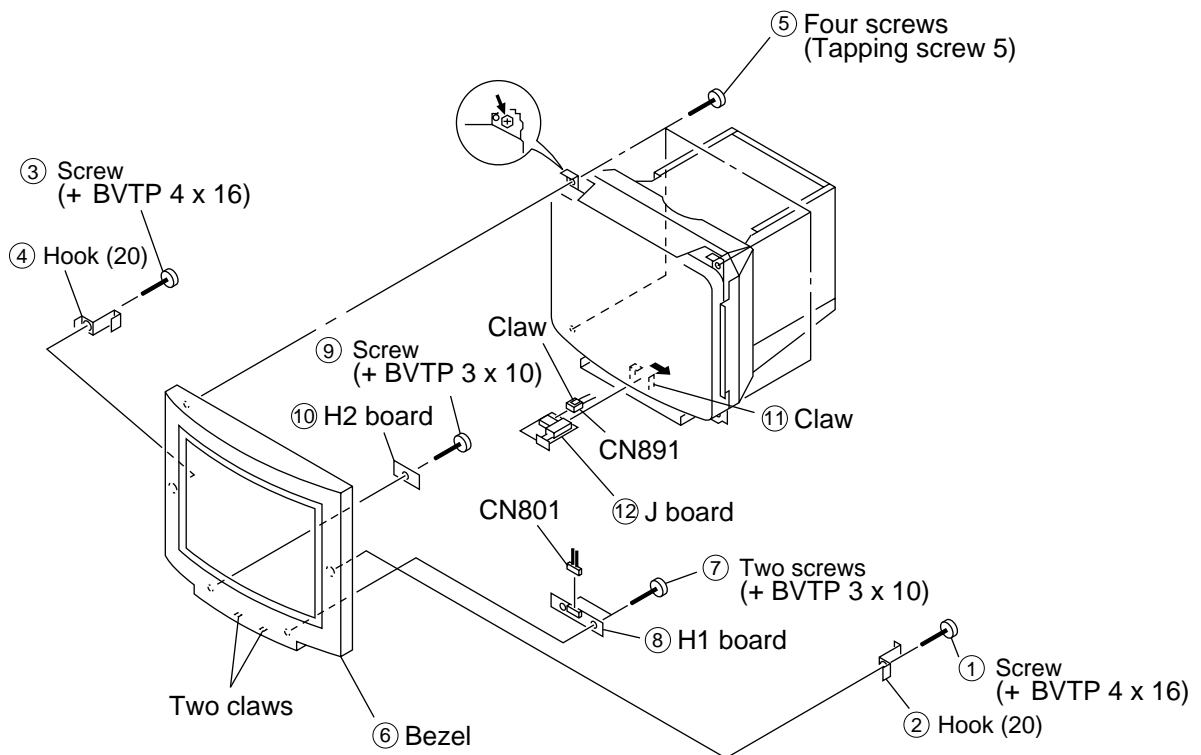

2-9. PICTURE TUBE REMOVAL

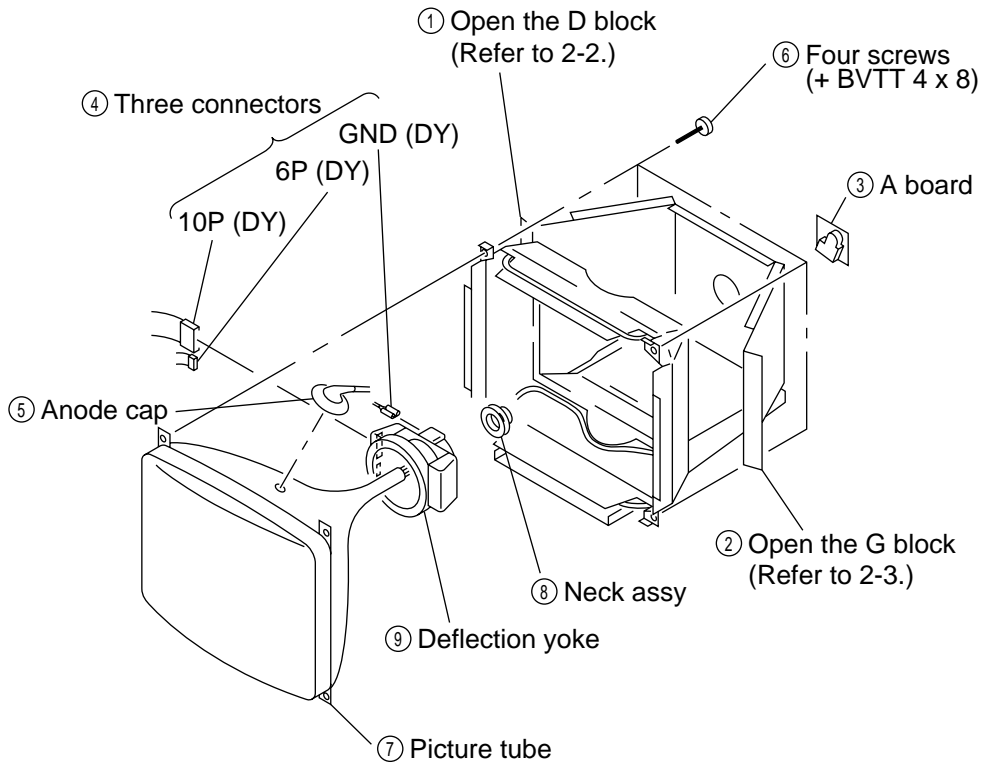

• REMOVAL OF ANODE-CAP

NOTE: Short circuit the anode of the picture tube and the anode cap to the metal chassis, CRT shield or carbon painted on the CRT, after removing the anode.

• REMOVING PROCEDURES

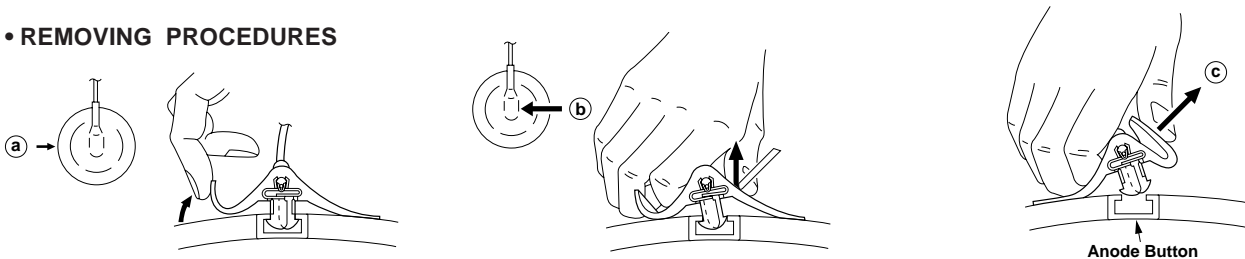

- ① Turn up one side of the rubber cap in the direction indicated by the arrow ①.
- ② Using a thumb pull up the rubber cap firmly in the direction indicated by the arrow ②.
- ③ When one side of the rubber cap is separated from the anode button, the anode-cap can be removed by turning up the rubber cap and pulling up it in the direction of the arrow ③.

• HOW TO HANDLE AN ANODE-CAP

- ① Don't hurt the surface of anode-caps with sharp shaped material!
- ② Don't press the rubber hardly not to hurt inside of anode-caps! A material fitting called as shatter-hook terminal is built in the rubber.
- ③ Don't turn the foot of rubber over hardly! The shatter-hook terminal will stick out or hurt the rubber.

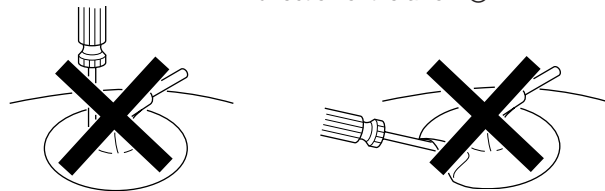

SECTION 3

SAFETY RELATED ADJUSTMENT

When replacing or repairing the shown below table, the following operational checks must be performed as a safety precaution against X-rays emissions from the unit.

	Part Replaced (▣)
HV Regulator Circuit Check	D Board IC901, T902 • Mounted D board
HV Protector Circuit Check	D Board Q660, Q661, D916, D935, C924, R665, R667, R940, R980, T902 • Mounted D board G Board PH680, Q680, Q683, D680, R680, R685, R686, R687, R688, R689 • Mounted G board
Beam Current Protector Circuit Check	D Board IC901, D904, D907, D908, R011, R908, R909, R921, R925, R926, R929, R930, T902 • Mounted D board

Check Condition

Input voltage : 100 ~ 240 VAC

Input signal : White Cross Hatch at 107 kHz

Beam control : BRT and CONT → Minimum

B+ voltage : 195 ~ 205 VDC

a) HV Regulator Circuit Check

- 1) Confirm that the voltage of the pin ② of CN901 on D board is within the voltage range shown below.
Standard: 9.00 ± 0.065 VDC

b) HV Protector Circuit Check

- 1) Confirm that the HV protector circuit works and TV Raster disappears when apply the voltage as shown below between pin ③ of CN901 on D board and GND using an external DC power supply.
Check Condition: Less than 34.10 VDC

c) Beam Current Protector Circuit Check-1

- 1) Measure HV voltage and record that value.
- 2) Shorted between pin ① and pin ④ of CN901 on D board.
- 3) Connect to the Constant Current Jig (A) between pin ① of CN901 on D board and GND, confirm that the Beam Current Protector Circuit works and HV go down more than 1.25 kV from the value of (1).
Check Condition: 1.50 mA

d) Beam Current Protector Circuit Check-2

- 1) Connect to the Constant Current Jig (B) between pin ① of CN901 on D board and GND, confirm that the Beam Current Protector Circuit works and TV Raster disappears.
Check Condition: 1.59 mA

e) Voltage of 3rd winding of FBT

- 1) Confirm that the voltage of pin ③ of CN901 on D board is within the voltage range shown below.
Standard: more than 28.0 VDC

SECTION 4 ADJUSTMENTS

Note: Hand degauss must be used on stand-by or power-off condition.

This model has an automatic earth magnetism correction function by using an earth magnetism sensor and a LCC coil. When using a hand degauss while monitor (LCC coil) is being operated, it sometimes gets magnetized, and the system may not work properly as a result.

• **Landing Rough Adjustment**

1. Enter the full white signal. (or the full black dots signal).
2. Adjust the contrast to the maximum.
3. Make the screen monogreen.

Note: Off the outputs from R ch and B ch of SG.

4. Reverse the DY, and adjust coarsely the purity magnet so that a green raster positions in the center of screen.
5. Adjust the tilt of DY, and fix lightly with a clamp.

Note: "TILT" shall be set at 0.

• **Landing Fine Adjustment**

1. Put the set inside the Helmholtz coil. ("LCC SW" = "12")
2. Input the single green signal and set the CONT control to MAX.

Note: After the W/B adjustment with 9300K, measure an average of ΣI_k when a full white signal is entered in the CONT MAX/BRT CENT status. Then make adjustment so that the specified screen can be attained after aging for 2 hours with I_k equivalent to 30% of the average value.

3. Demagnetize the metal part of the chassis with the hand degausser and coil degausser, and the CRT surface with the hand degausser.

Input AC 230V to AC IN, turn on and off the power to perform auto degaussing. (Perform auto degaussing by setting "MON CON REG2"=152. Return to the original value after use.)

Demagnetize the CRT surface with the hand degausser again.

Note:

- (1) Hand degauss must be used on stand-by or power-off condition.

This model has an automatic earth magnetism correction function by using an earth magnetism sensor and a LCC coil. When using a hand degauss while monitor (LCC coil) is being operated, it sometimes gets magnetized, and the system may not work properly as a result.

- (2) Adjust in a non-magnetic field. $B_V=45\mu T$.
- (3) If adjusting in a magnetic fields, add the shift from the non-magnetic field in your estimation.

4. Attach the wobbling coil to the designated part of the CRT neck.

5. Attach the sensor of the landing adjustment unit on the CRT surface.

6. Adjust the DY position and purity, and the DY tilt, and landing of the center and 4 corners with the landing checker.

After adjustment, set "LCC SW" to "13".

- Write terrestrial magnetism sensor reading VX and VY to "LCC VX" and LCC VY" respectively. Adjust the landing by moving "LCC NS", "LCC LT", "LCC LB", "LCC RT" and "LCC RB". However, the register adjustment must be limited within the following range.

"LCC NS"	128 ± 15
"LCC LT", "LCC LB", "LCC RT", "LCC RB"	128 ± 40

Save the service data.

<Specifications>

Adjust so that the green is within the specification given right.

4 corner adjust target : within ± 1

(μm)		
0 ± 3	0 ± 7.5	0 ± 3
0 ± 5	0 ± 5	0 ± 5
0 ± 3	0 ± 7.5	0 ± 3

The red and blue must be within the specification given right with respect to the green.

(μm)		
± 6	± 6	± 6
± 6	± 4	± 6
± 6	± 6	± 6

A difference between red and blue must be within the specification given right.

(μm)		
10	10	10
10	7	10
10	10	10

* Adjustment and measurement should be made at the points one inch inside the fluorescent screen.

7. For the up/down swing, swing the DY and insert a wedge so that the up and down pins are equal at the top and bottom. Adjust the DY TLV VR so that the horizontal trapezoid is equal at the left and right. Insert the wedge firmly so that the DY does not shake.

8. Check the landing of each corner, and if it does not satisfy the specification, adjust the landing of four corners using "LCC LT", "LCC LB", "LCC RT" and "LCC RB".

However, the register adjustment must be limited within the following range.

"LCC NS"	128 ± 15
"LCC LT", "LCC LB", "LCC RT", "LCC RB"	128 ± 40

After adjustment, save the service data.

9. Remove the sensor and wobbling coil.
10. Switch the signal to R.G.B., and check that each color is pure.
11. Check that the DY is not tilting.

Connect the communication cable of the computer to the connector located on the D board on the monitor. Run the service software and then follow the instruction.

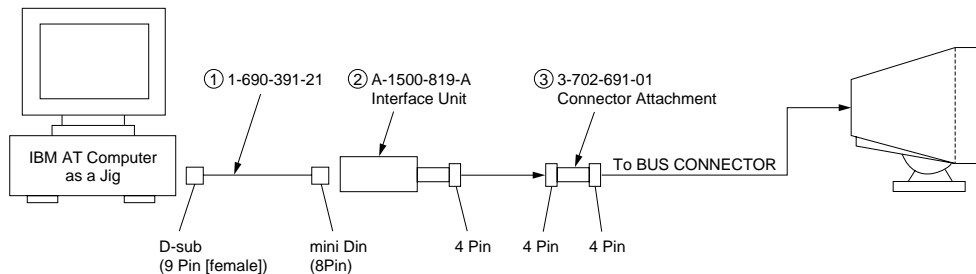

*The parts above (1) ~ (3) are necessary for DAS adjustment.

Convergence Rough Adjustment

- (1) Receive an image of the white crosshatch signals (white lines on black).
- (2) Place the protrusions of the 6-fold poles magnet attached to the CRT neck upon each other. (Fig. 1)
- (3) Make rough adjustment of the H and V direction convergence by using 4-fold poles magnet.
- (4) Make a rough adjustment of the V direction convergence by using "V. STAT".

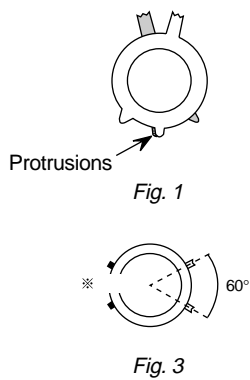

* Set so that the protruding parts of the 2 magnet rings agree with each other.

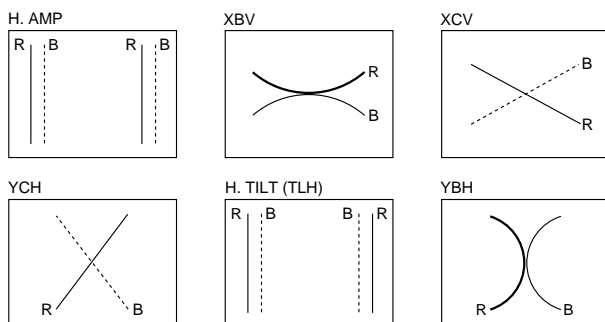

Convergence Specification

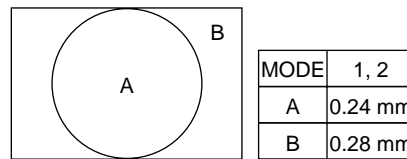

White Balance Adjustment Specification

- | | |
|--|--|
| (1) 9300K
$x = 0.283 \pm 0.005$
$y = 0.298 \pm 0.005$
(All White) | (3) 5000K
$x = 0.346 \pm 0.005$
$y = 0.359 \pm 0.005$
(All White) |
| (2) 6500K
$x = 0.313 \pm 0.005$
$y = 0.329 \pm 0.005$
(All White) | |

Vertical and Horizontal Position and Size Specification

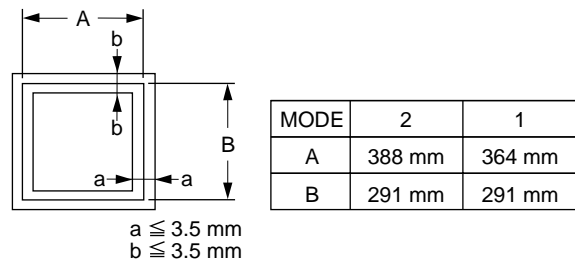

Focus adjustment

Adjust the focus volume 1 and 2 (HDK 1 and 2) for the optimum focus.

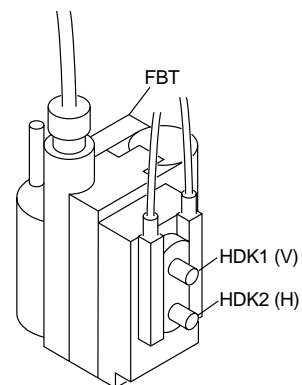

SECTION 5
DIAGRAMS

5-1. BLOCK DIAGRAMS

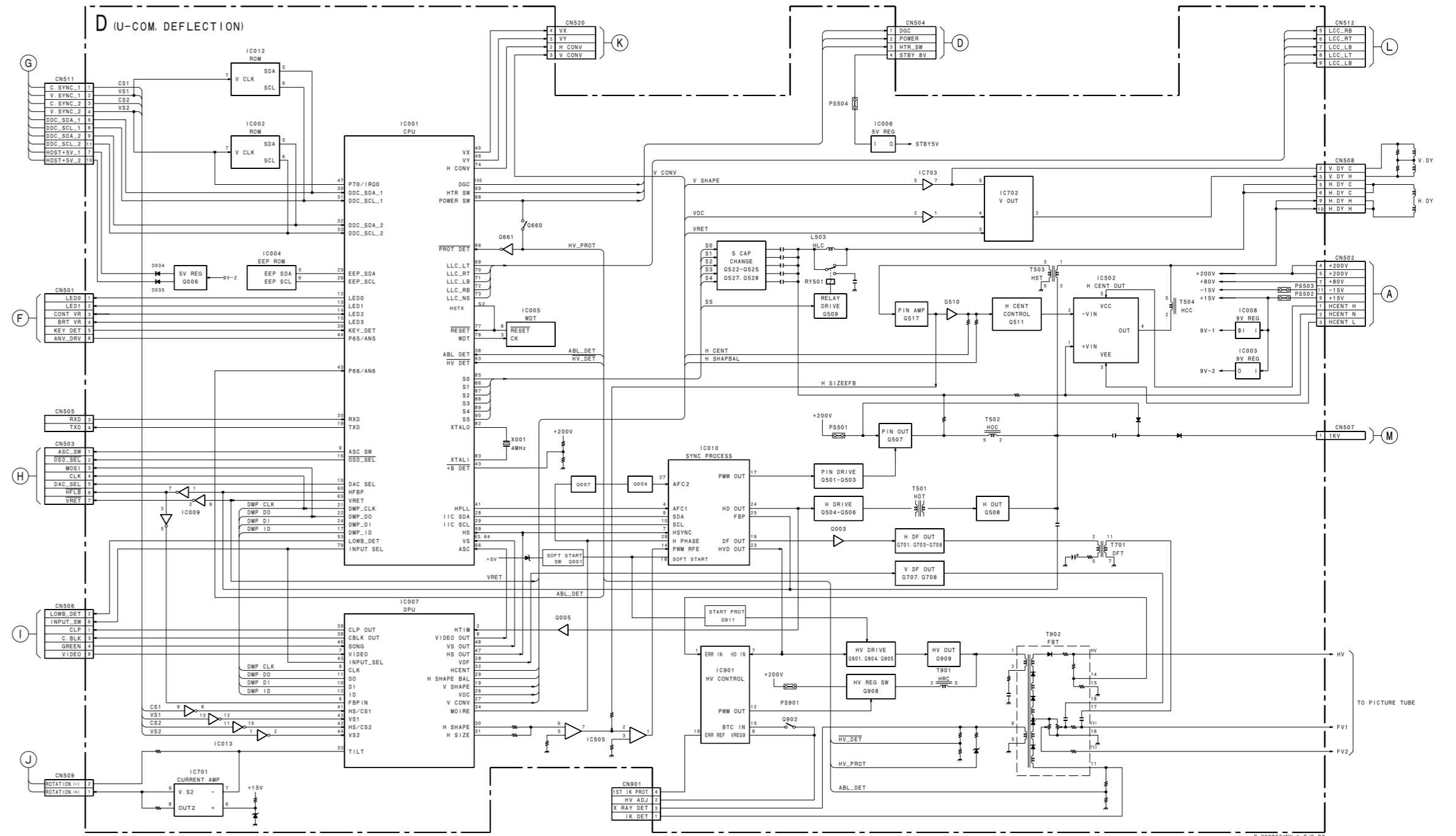
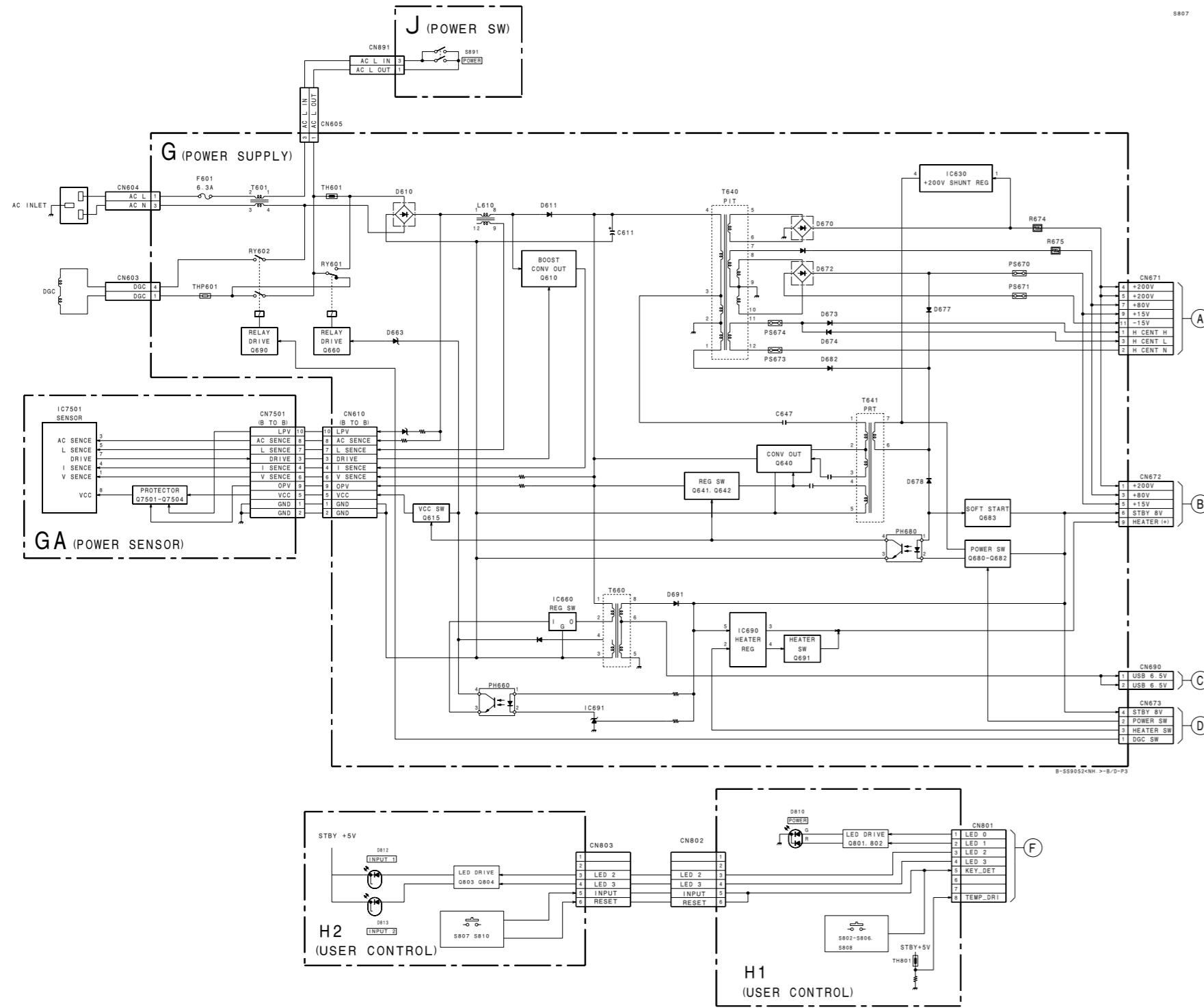

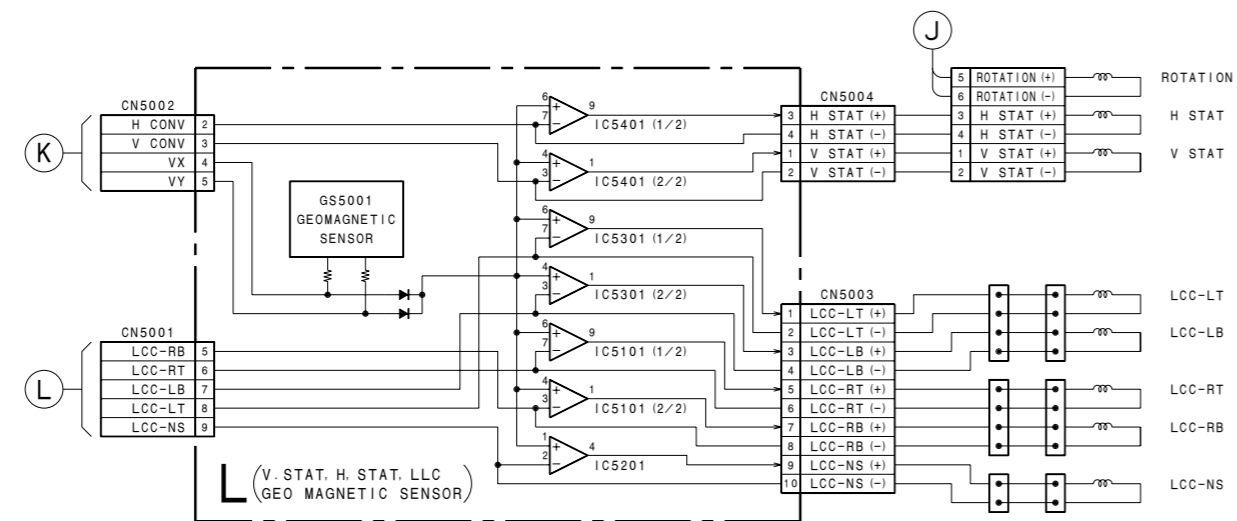
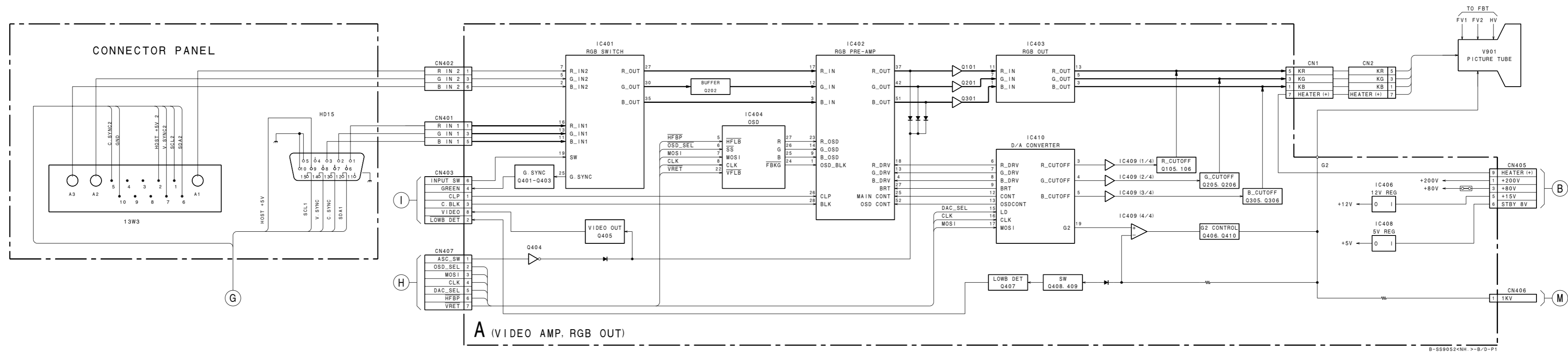

5-2. FRAME SCHEMATIC DIAGRAM

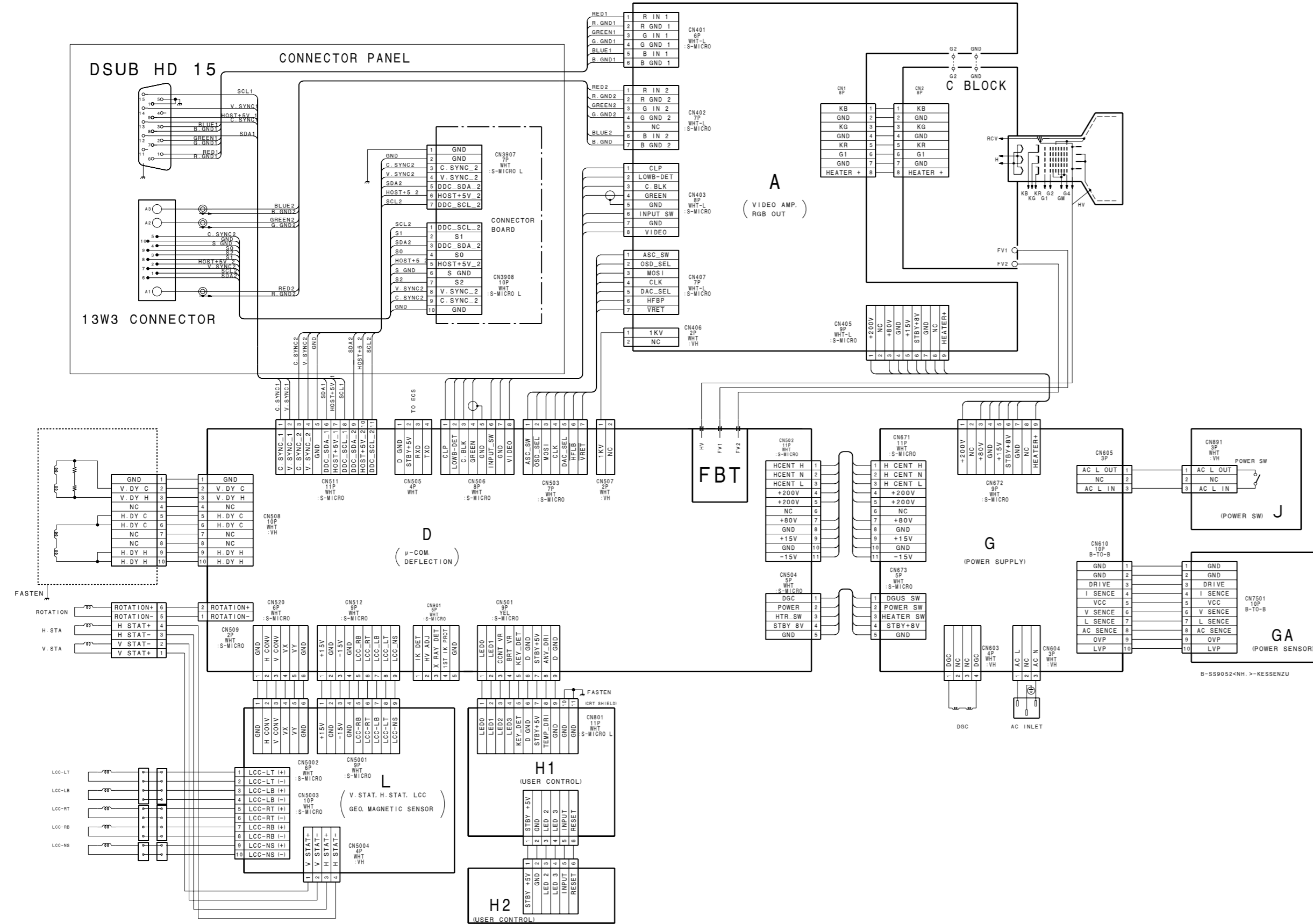

5-3. CIRCUIT BOARDS LOCATION

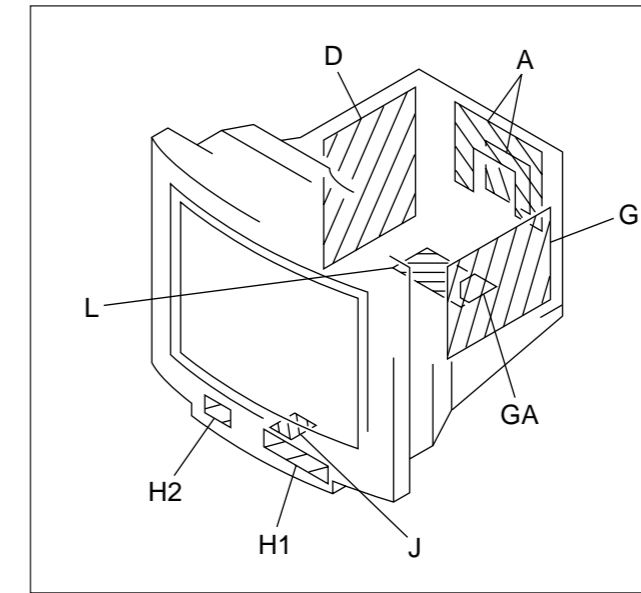

Note: The components identified by shading and mark are critical for safety. Replace only with part number specified.

Note: Les composants identifiés par un tramé et une marque sont critiques pour la sécurité. Ne les remplacer que par une pièce portant le numéro spécifié.

- All voltages are in V.
- Readings are taken with a 10 M digital multimeter.
- Readings are taken with a color-bar signal input.
- Voltage variations may be noted due to normal production tolerances.
- * : Can not be measured.
- Circled numbers are waveform references.
- : B + bus.
- : B - bus.

5-4. SCHEMATIC DIAGRAMS AND PRINTED WIRING BOARDS

Note:

- All capacitors are in μF unless otherwise noted. (pF: μpF)
- Capacitors without voltage indication are all 50 V.
- Indication of resistance, which does not have one for rating electrical power, is as follows.

Pitch: 5 mm
Rating electrical power 1/4 W (CHIP : 1/10 W)

- All resistors are in ohms.
- : nonflammable resistor.
- : fusible resistor.
- : internal component.
- : panel designation, and adjustment for repair.
- All variable and adjustable resistors have characteristic curve B, unless otherwise noted.
- : earth-ground.
- : earth-chassis.
- The components identified by in this basic schematic diagram have been carefully factory-selected for each set in order to satisfy regulations regarding X-ray radiation. Should replacement be required, replace only with the value originally used.
- When replacing components identified by , make the necessary adjustments indicated. (See page 3-1)
- When replacing the part in below table, be sure to perform the related adjustment.

		Part replaced ()
HV Regulator Circuit Check	D Board	IC901, T902 • Mounted D board
HV Protector Circuit Check	D Board	Q660, Q661, D916, D935, C924, R665, R667, R940, R980, T902 • Mounted D board
Beam Current Protector Circuit Check	G Board	PH680, Q680, Q683, D680, R680, R685, R686, R687, R688, R689 • Mounted G board
Beam Current Protector Circuit Check	D Board	IC901, D904, D907, D908, R011, R908, R909, R921, R925, R926, R929, R930, T902 • Mounted D board

Terminal name of semiconductors in silk screen printed circuit (※)

Device	Printed symbol	Terminal name	Circuit
① Transistor		Collector Base Emitter	
② Transistor		Collector Base Emitter	
③ Diode		Cathode Anode	
④ Diode		Cathode Anode (NC)	
⑤ Diode		Cathode Anode (NC)	
⑥ Diode		Common Anode Cathode	
⑦ Diode		Common Anode Cathode	
⑧ Diode		Common Anode Anode	
⑨ Diode		Common Cathode Cathode	
⑩ Diode		Common Cathode Cathode	
⑪ Diode		Common Cathode Cathode	
⑫ Diode		Common Anode Cathode Anode Cathode	
⑬ Transistor (FET)		Drain Gate Source	
⑭ Transistor (FET)		Drain Gate Source	
⑮ Transistor (FET)		Source Drain Gate	
⑯ Transistor		Emitter Collector Base	

(Chip semiconductors that are not actually used are included.)

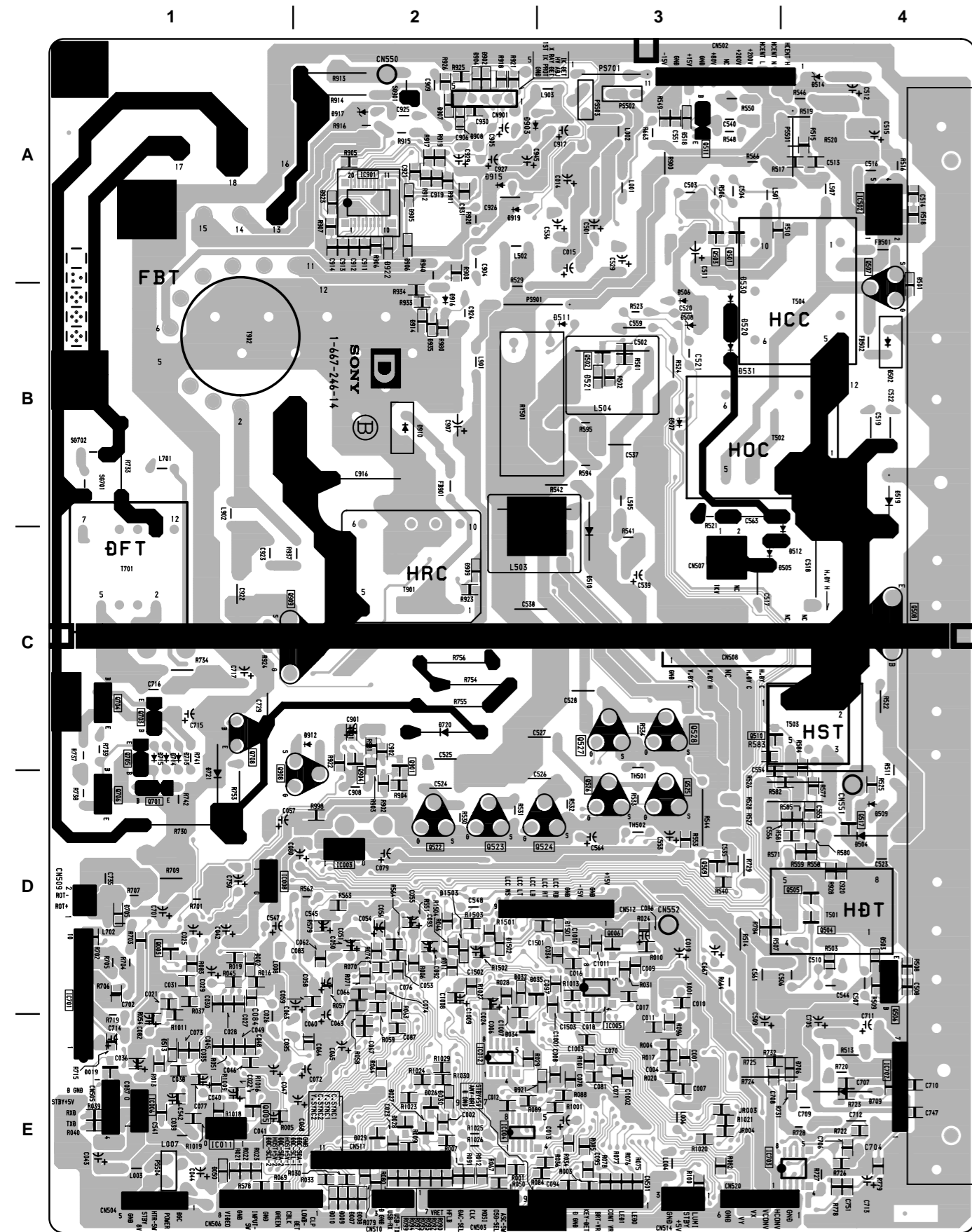

• D BOARD SEMICONDUCTOR LOCATION

IC		TRANSISTOR		DIODE		CRYSTAL	
(Conductor Side)	(Component Side)	(Conductor Side)	(Component Side)*	(Conductor Side)	(Component Side)*	(Conductor Side)	(Component Side)
IC001	E-2	Q001	D-4	D004	E-2	X001	D-3
IC002	E-3	Q003	D-1	D007	E-2		
IC003	D-3	Q004	D-4	D008	E-2		
IC004	E-2	Q005	E-1	D009	E-2		
IC005	D-3	Q006	D-3	D010	E-2		
IC006	E-1	Q007	D-4				
IC007	D-3	Q501	A-3				
IC008	D-1	Q502	B-3				
IC009	D-2	Q503	A-3				
IC010	E-4	Q504	D-4				
IC011	E-1	Q505	D-4				
IC012	E-2	Q506	D-4				
IC013	E-3	Q507	A-4				
IC502	A-4	Q508	C-4				
IC505	D-3	Q509	D-3				
IC701	D-1	Q510	C-3				
IC702	E-4	Q511	A-3				
IC703	E-3	Q512	A-2				
IC901	A-2	Q517	D-4				
		Q522	D-2				
		Q523	D-2				
		Q524	D-3				
		Q525	D-3				
		Q526	D-3				
		Q527	C-3				
		Q528	C-3				
		Q660	D-2				
		Q661	D-2				
		Q701	D-1				
		Q703	C-1				
		Q704	C-1				
		Q705	C-1				
		Q706	D-1				
		Q707	D-3				
		Q708	C-1				
		Q901	C-2				
		Q902	A-3				
		Q904	C-2				
		Q905	C-3				
		Q908	D-2				
		Q909	C-2				
		Q911	D-3				
D012	E-2						
D013	E-2						
D014	E-2						
D015	E-2						
D016	E-2						
D019	E-1						
D020	E-4						
D025	D-4						
D026	E-2						
D027	E-2						
D028	E-2						
D029	E-2						
D032	D-2						
D033	E-2						
D034	E-2						
D035	D-3						
D050	E-1						
D501	B-4						
D502	B-4						
D503	D-4						
D504	D-4						
D505	C-3						
D506	B-3						
D507	B-3						
D508	B-3						
D509	D-4						
D510	C-3						
D511	B-3						
D512	C-4						
D513	E-1						
D514	A-4						
D516	A-1						
D517	D-2						
D518	A-3						
D519	B-4						
D520	B-3						
D521	B-3						
D660	D-2						
D701	D-4						
D704	D-5						
D705	D-1						
D706	E-4						
D709	E-4						
D713	C-1						
D714	C-1						
D715	C-1						
D718	D-4						
D720	C-2						
D721	D-1						
D901	C-3						
D902	A-2						
D903	A-2						
D904	A-2						
D905	A-2						
D906	A-2						
D907	A-2						
D908	A-2						
D909	C-2						
D910	B-2						
D911	C-3						
D913	A-3						
D915	A-2						
D916	B-2						
D917	A-2						
D919	A-2						
D921	E-3						
D922	A-2						
D923	A-2						
D924	E-2						
D935	B-2						
D1501	D-3						
D1502	D-2						
D1503	D-2						

*: Refer to Terminal name of semiconductors in silk screen printed circuit (see page 5-9)

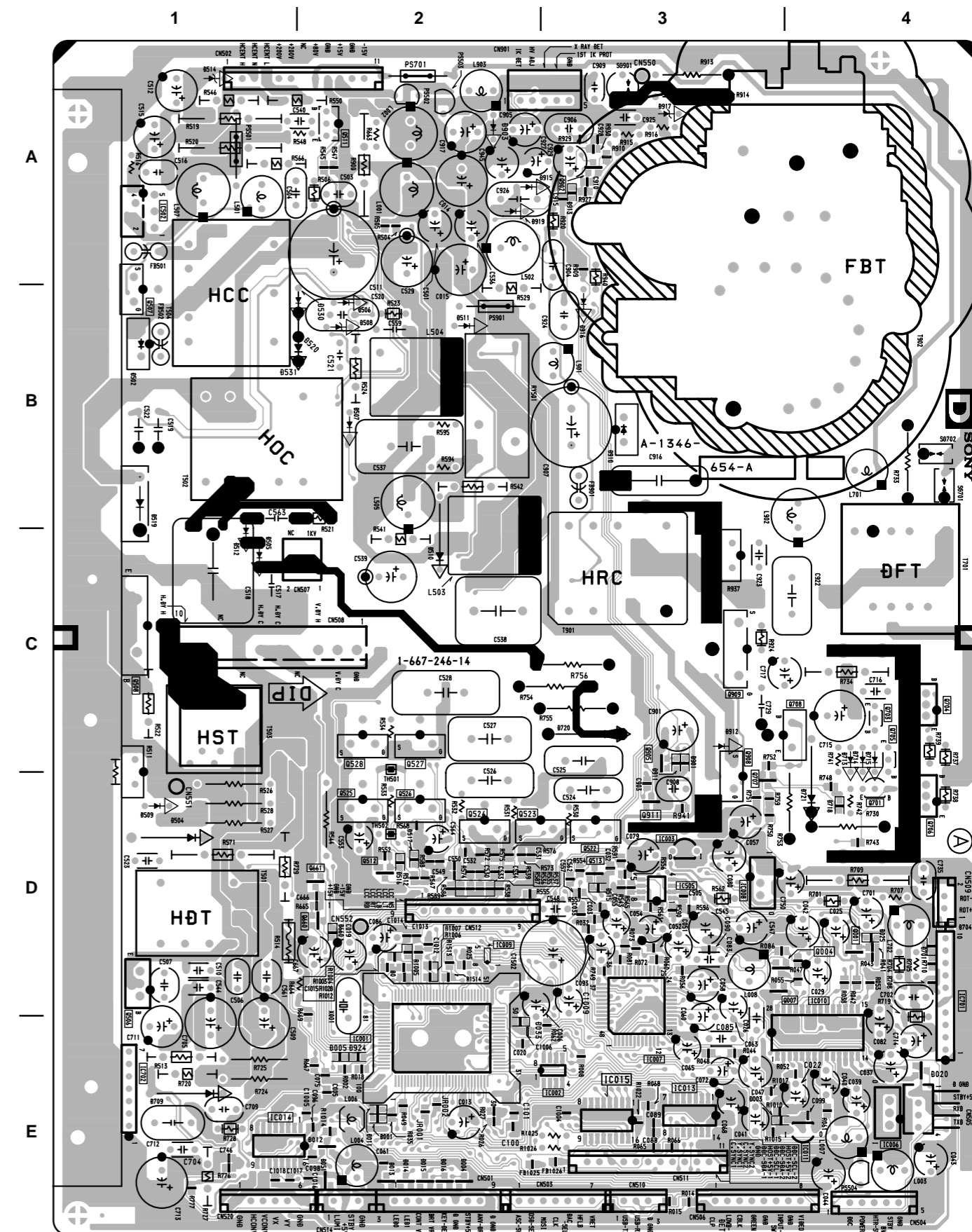

NOTE:
The circuit indicated as left contains high voltage of over 600 Vp-p. Care must be paid to prevent an electric shock in inspection or repairing.

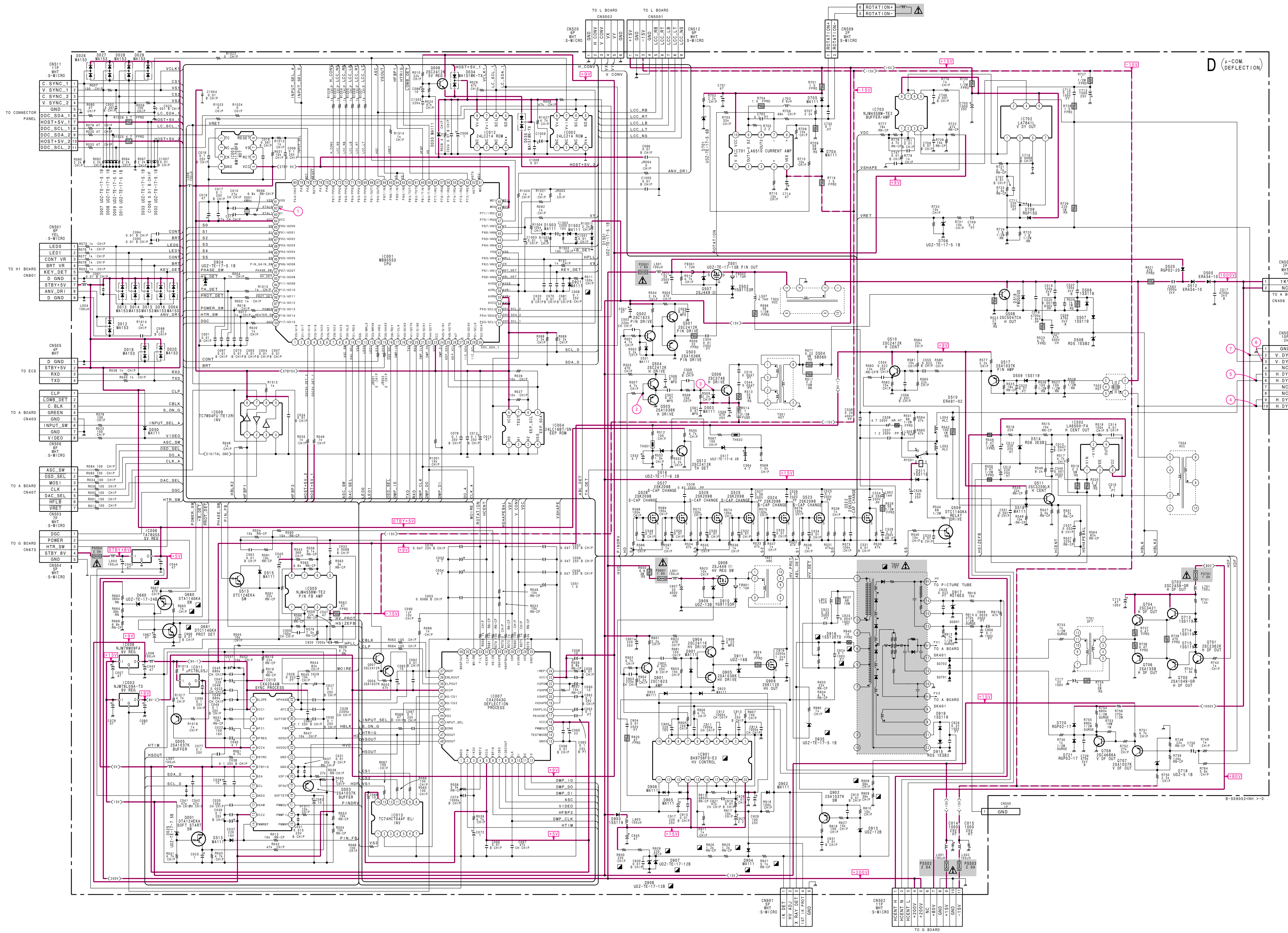

• D BOARD WAVEFORMS

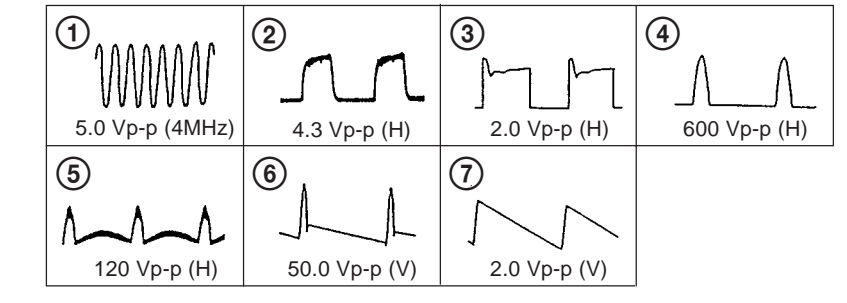

• D BOARD IC701 LA6510

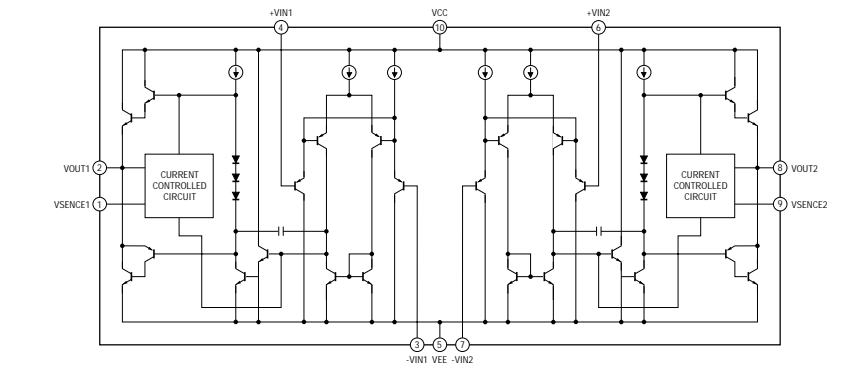

• D BOARD VOLTAGE LIST

Ref.	Pin No.	Voltage [V]	Ref.	Pin No.	Voltage [V]
IC002	5	1.1	11	0	
	6	4.2	11.2	0	
	7	0	15	0	
			16	8.4	
			19	9.2	
IC004	5	4.8	Q003	B	2.5
	6	4.8		C	0
IC005	1	0.4	Q005	E	5.1
	3	0		B	0
	7	1.5		C	5.7
	8	4.8		E	3.1
IC009	1	-0.1	Q501	B	11.2
	2	4.7		C	0
	5	2.3		E	11.2
	6	0.3	Q501	B	13.8
	7	0.3		C	10.8
	8	4.5		E	11.2
IC010	1	4.0	Q502	B	0.2
	3	3.0		C	11.2
	4	2.8	Q503	B	11.2
	5	2.5		C	10.9
	6	2.6	Q504	B	2.5
	7	0.6		C	12.0
	9	4.8	Q505	B	2.5
	10	4.8		C	2.4
	12	5.4	Q505	B	2.5
	14	4.5		C	2.4
	15	4.5	Q506	B	-14.0
	16	5.4		C	-0.2
	17	1.0	Q506	B	-14.0
	18	0		C	-14.0
	19	5.1	Q507	G	19.4
	20	3.7		D	41.8
	23	0.8	Q508	B	-14.0
	24	2.5		C	41.0
	25	-0.1	Q509	B	0
	26	4.0		C	14.1
	27	4.0		E	
	28	4.4			
IC012	5	0.6	IC012	5	0.6
	6	3.9	IC012	6	3.9
	7	4.1	IC012	7	4.1
IC013	1	0	IC013	1	0
	2	4.9	IC013	2	4.9
	8	0.6	IC013	8	0.6
	9	3.6	IC013	9	3.6
	10	4.9	IC013	10	4.9
	11	0	IC013	11	0
	13	5.7	IC013	13	5.7
IC014	1	3.5	IC014	1	3.5
	3	3.5	IC014	3	3.5
	5	2.7	IC014	5	2.7
	9	0	IC014	9	0
	10	0.1	IC014	10	0.1
	12	4.9	IC014	12	4.9
	13	4.9	IC014	13	4.9
	14	3.2	IC014	14	3.2
	15	3.9	IC014	15	3.9
IC015	1	0.5	IC015	1	0.5
	2	4.2	IC015	2	4.2
	3	0	IC015	3	0
	4	0.5	IC015	4	0.5
	5	0	IC015	5	0
	8	0	IC015	8	0
	9	0	IC015	9	0
	13	0	IC015	13	0
IC502	1	41.4	IC502	1	41.4
	2	41.4	IC502	2	41.4
	3	33.7	IC502	3	33.7
	4	42.3	IC502	4	42.3
	5	48.3	IC502	5	48.3
IC505	1	4.5	IC505	1	4.5
	3	0	IC505	3	0
	5	0	IC505	5	0
	6	0	IC505	6	0
	7	-10.0	IC505	7	-10.0
IC701	1	14.2	IC701	1	14.2
	2	14.2	IC701	2	14.2
	4	3.6	IC701	4	3.6
	6	3.0	IC701	6	3.0
	7	3.0	IC701	7	3.0
	8	-0.7	IC701	8	-0.7
	9	-0.7	IC701	9	-0.7
IC702	2	0.4	IC702	2	0.4
	3	13.5	IC702	3	13.5
	4	1.2	IC702	4	1.2
	5	1.2	IC702	5	1.2
IC703	1	1.2	IC703	1	1.2
	2	1.6	IC703	2	1.6
	3	1.6	IC703	3	1.6
	5	2.8	IC703	5	2.8
	6	2.8	IC703	6	2.8
	7	2.8	IC703	7	2.8
IC901	1	9.3	IC901	1	9.3
	2	5.6	IC901	2	5.6
	4	5.0	IC901	4	5.0
	6	1.1	IC901	6	1.1
	7	0.9	IC901	7	0.9
	8	9.3	IC901	8	9.3
	10	0	IC901	10	0
Q701	B	5.7	Q701	B	5.7
	C	36.0	Q701	C	36.0
	E	5.1	Q701	E	5.1
Q703	B	37.9	Q703	B	37.9
	E	37.4	Q703	E	37.4
Q704	B	37.4	Q704	B	37.4
	E	37.0	Q704	E	37.0
Q705	B	36.0	Q705	B	36.0
	E	36.6	Q705	E	36.6
Q706	B	36.6	Q706	B	36.6
	E	37.0	Q706	E	37.0
Q707	B	-0.6	Q707	B	-0.6
	C	-5.0	Q707	C	-5.0
	E	0	Q707	E	0
Q708	B	0.6	Q708	B	0.6
	C	477.0	Q708	C	477.0
Q901	B	0.1	Q901	B	0.1
	C	9.9	Q901	C	9.9
Q902	B	9.0	Q902	B	9.0
	C	0	Q902	C	0
	E	9.0	Q902	E	9.0
Q904	B	8.6	Q904	B	8.6
	C	13.0	Q904	C	13.0
	E	8.4	Q904	E	8.4
Q905	B	8.6	Q905	B	8.6
	C	8.4	Q905	C	8.4
Q908	G	196.6	Q908	G	196.6
	D	40.1	Q908	D	40.1
Q909	G	8.4	Q909	G	8.4
	D	40.4	Q909	D	40.4

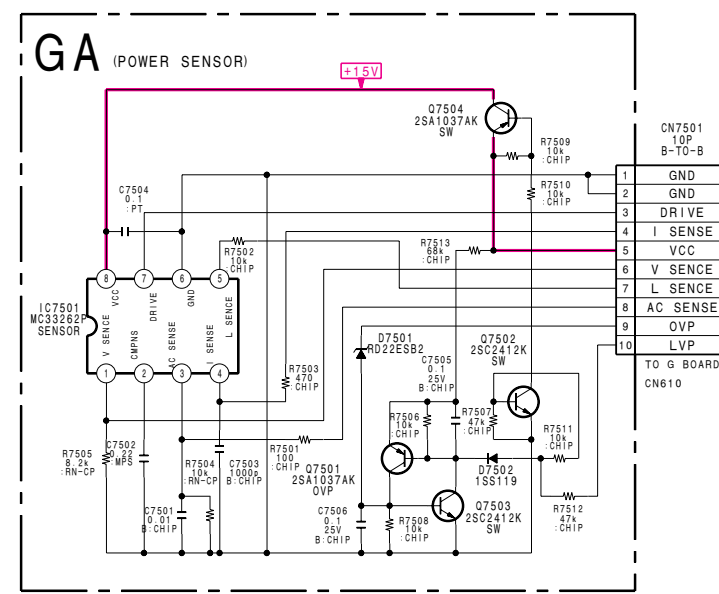

• GA BOARD VOLTAGE LIST

Ref.	Pin No.	Voltage [V]
IC7501	1	2.6
	2	2.5
	3	1.7
	4	0.2
	5	0
	7	8.6
	8	14.0
Q7501	B	0
	C	14.0
	E	14.0
Q7502	B	0.7
	C	0.1
Q7503	B	0
	C	14.0
Q7504	B	13.4

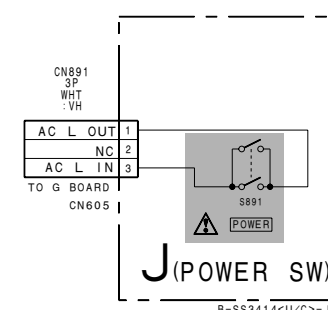
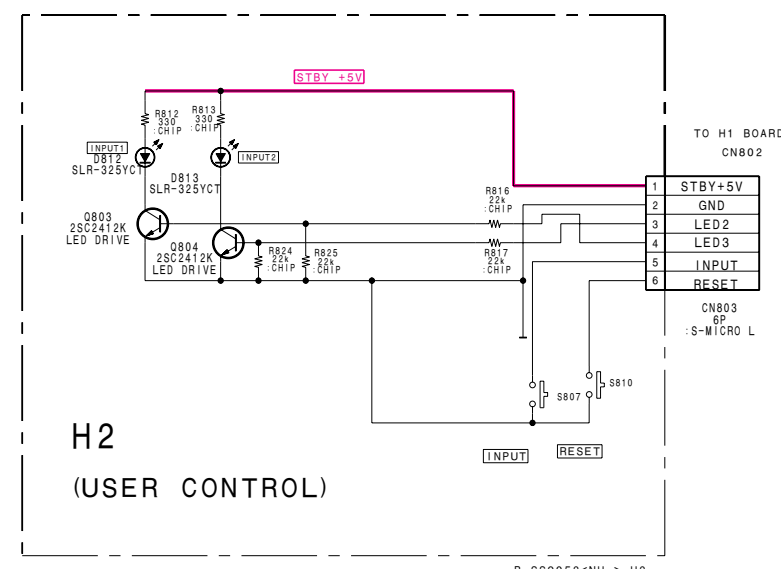
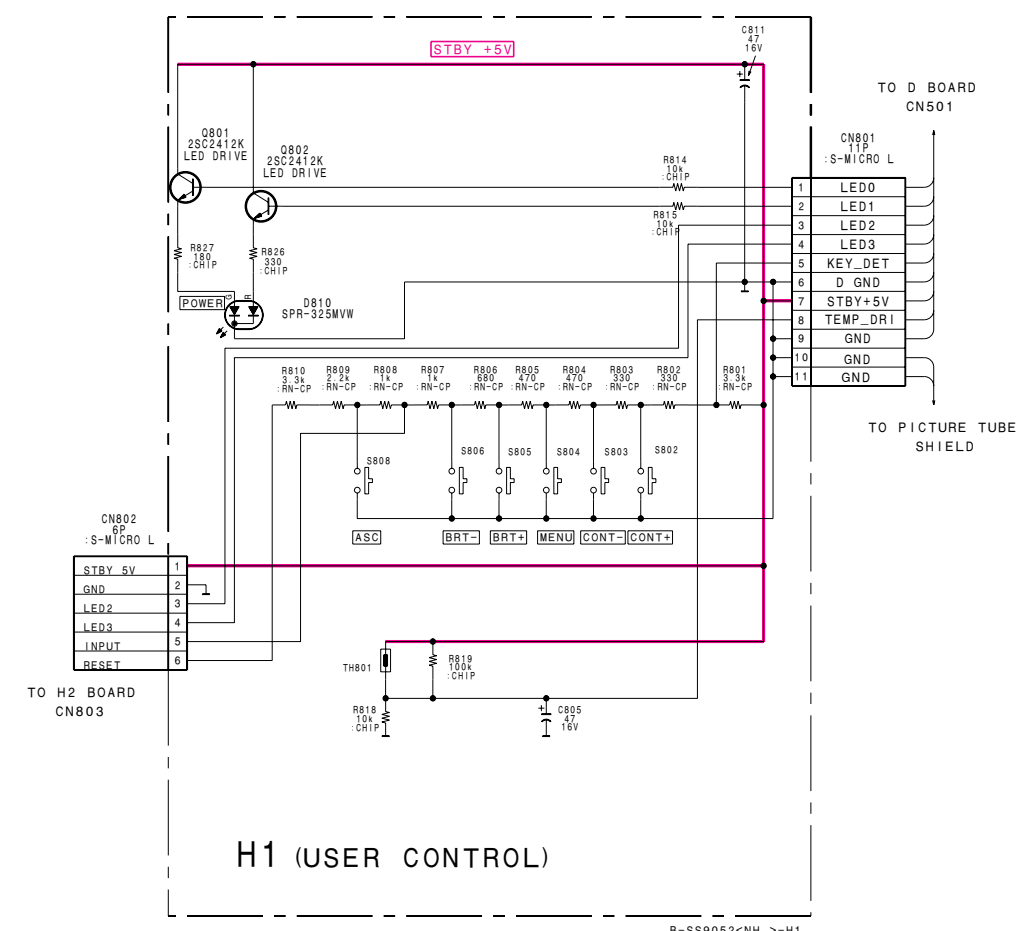

• L BOARD IC5101, 5301, 5401 LA6510

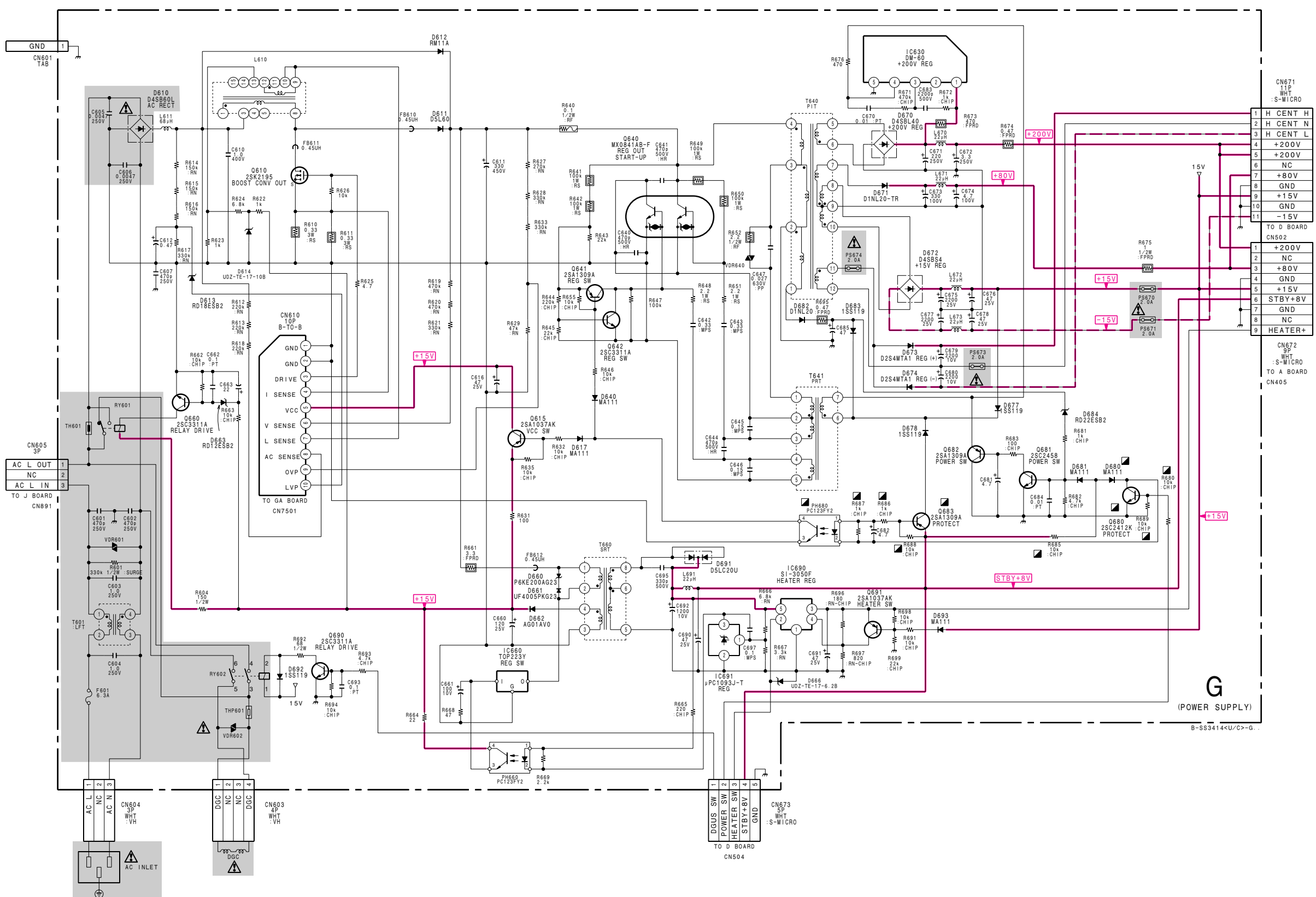
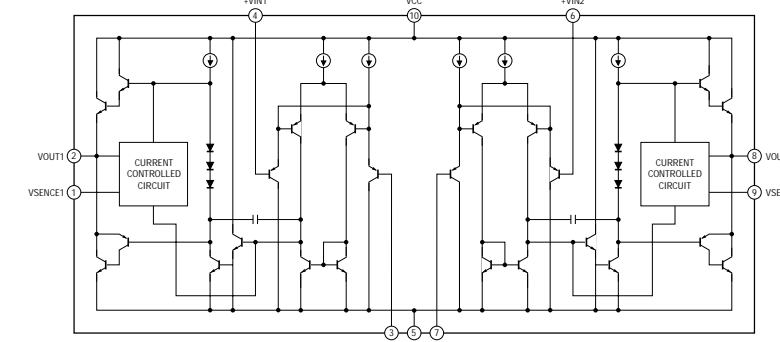

• G BOARD VOLTAGE LIST

Ref.	Pin No.	Voltage [V]
IC630	3	2.5
	4	11.6
IC660	IN	6.1
	OUT	410.0
IC690	2	5.0
	3	6.7
	4	5.3
	5	200V
PH660	1	4.5
	2	3.3
	3	6.1
	4	16.7
PH680	1	1.3
	2	0.1
	3	0
Q610	G	8.7
	D	102.4
	S	0.2
Q615	B	13.6
	C	14.2
	E	14.3
	NC	NC
Q640	B1	-2.0
	C1	199.2
	B2	196.8
	C2	408.0
Q641	B	1.1
	C	-2.0
	E	2.0
	NC	NC
Q642	B	-1.8
	C	-2.0
Q660	B	0.9
	C	0.3
Q680	B	0.8
	C	0
Q681	B	0.3
	C	11.7
Q682	B	11.7
	E	11.7
Q683	B	7.5
	C	8.3
Q690	B	0
	C	15.0
	E	0
	NC	NC
Q691	B	8.6
	C	5.3
	E	6.7
	NC	NC

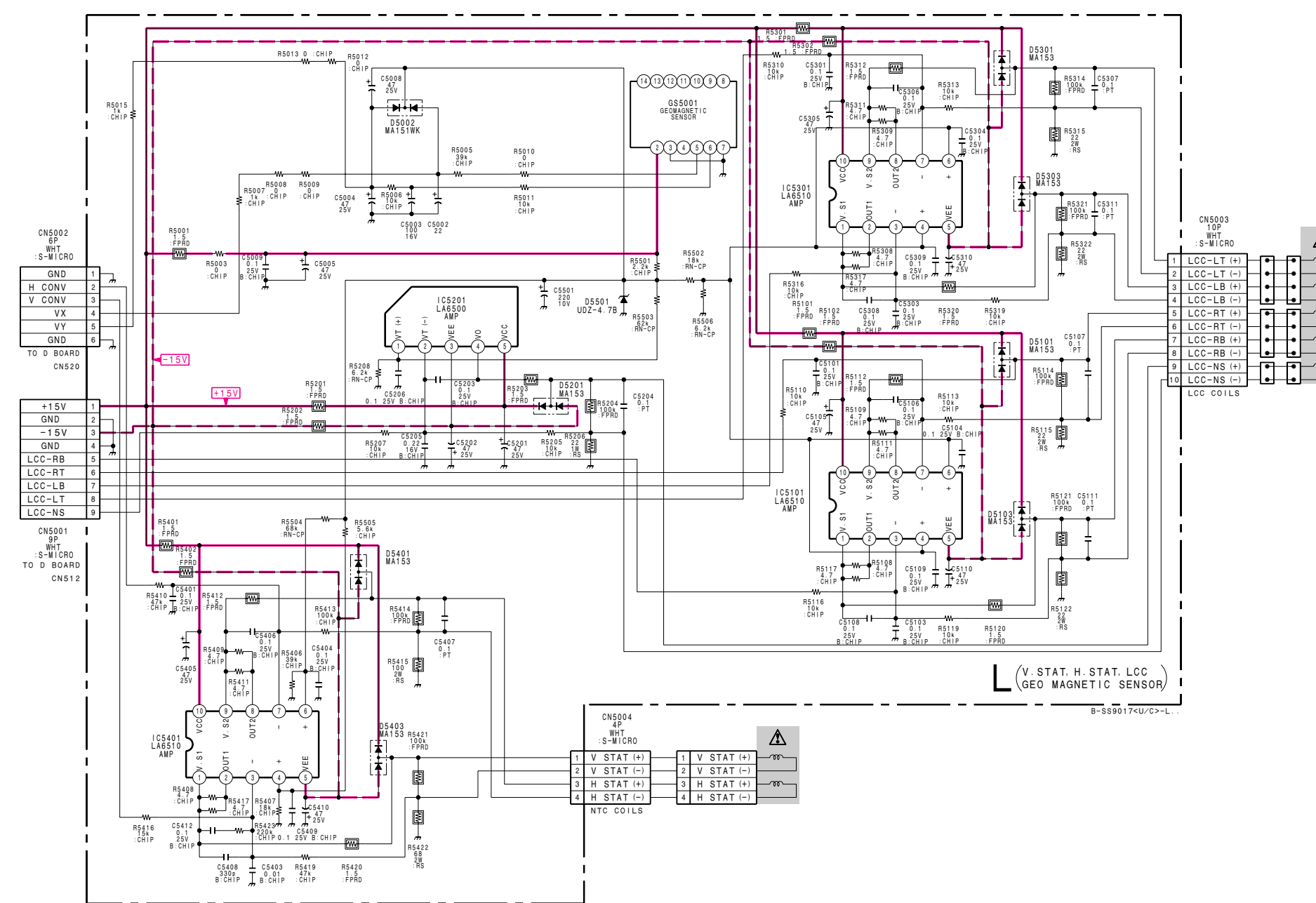

• L BOARD VOLTAGE LIST

Ref.	Pin No.	Voltage [V]
GS5001	5	2.8
	6	2.8
IC5101	1	1.0
	2	1.0
	3	1.2
	4	1.2
	6	1.2
	7	1.2
	8	-0.2
	9	-0.2
	10	1.2
IC5201	1	1.2
	2	1.2
	4	1.1
	NC	NC
IC5301	1	-0.2
	2	-0.2
	3	1.2
IC5401	1	0.6
	2	0.6
	3	3.4
	4	3.4
	6	1.8
	9	0.4

— G BOARD —

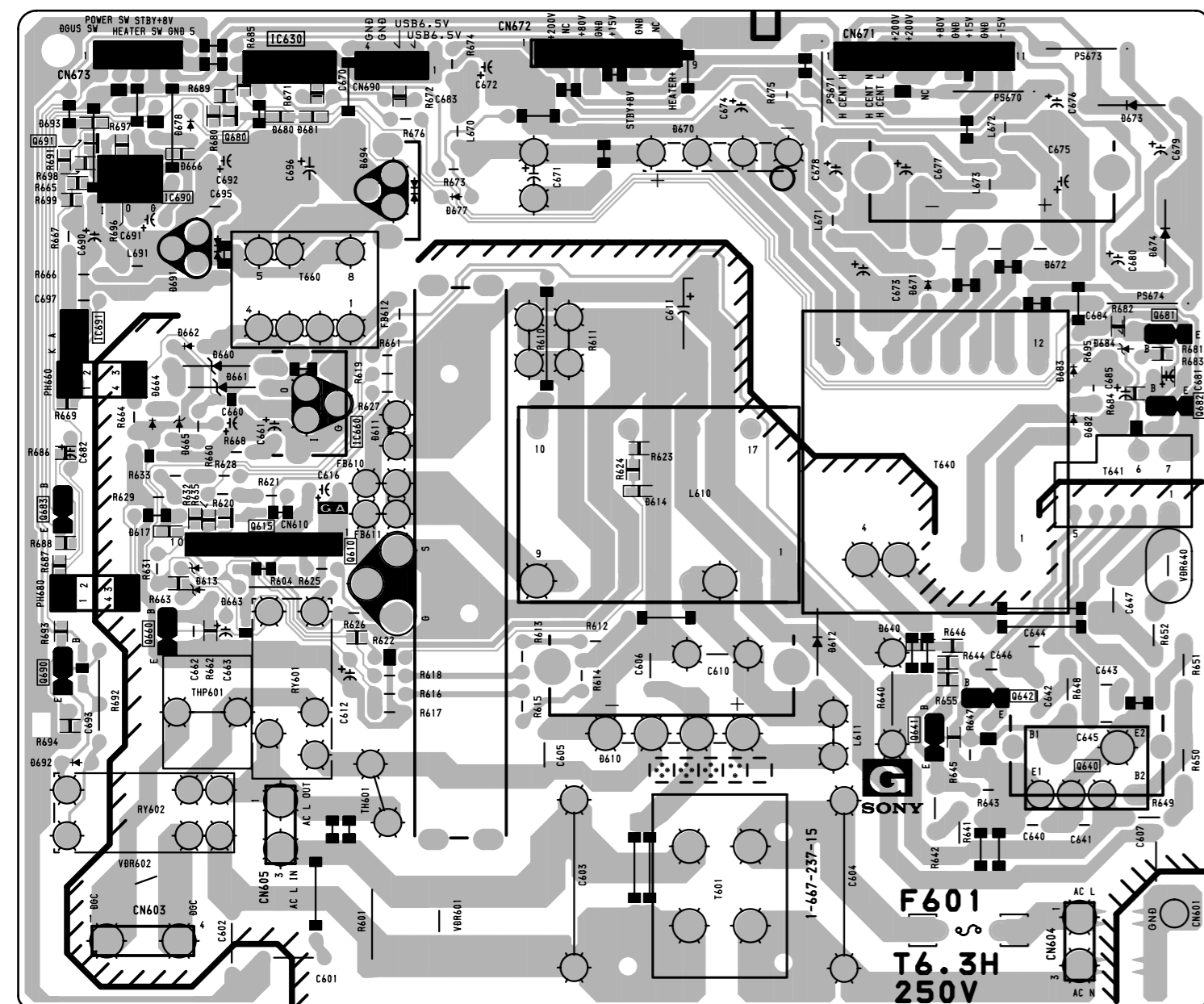

G BOARD
Terminal name of semiconductors in silk screen printed circuit (*)

Ref.	*
Q615, Q680, Q691	①
D614, D617, D640, D680, D681, D693	③

※: Refer to Terminal name of semiconductors in silk screen printed circuit (see page 5-9)

— H1 BOARD (Conductor Side) —

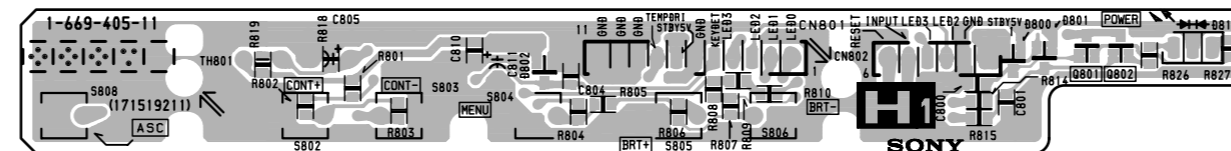

— H1 BOARD (Component Side) —

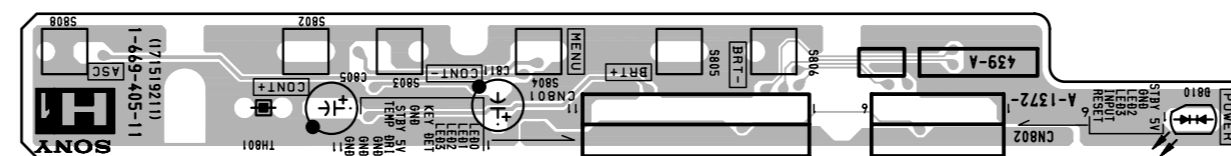

H1 BOARD
Terminal name of semiconductors in silk screen printed circuit (*)

Ref.	*
Q801, 802	①

※: Refer to Terminal name of semiconductors in silk screen printed circuit (see page 5-9)

— H2 BOARD (Conductor Side) —

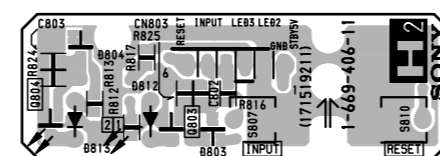

— H2 BOARD (Component Side) —

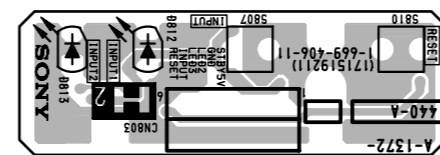

H2 BOARD
Terminal name of semiconductors in silk screen printed circuit (*)

Ref.	*
Q803, Q804	①

※: Refer to Terminal name of semiconductors in silk screen printed circuit (see page 5-9)

— GA BOARD —

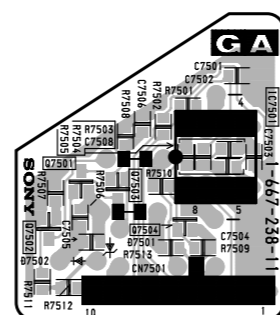

GA BOARD
Terminal name of semiconductors in silk screen printed circuit (*)

Ref.	*
Q7501-Q7504	①

※: Refer to Terminal name of semiconductors in silk screen printed circuit (see page 5-9)

— L BOARD (Conductor Side) —

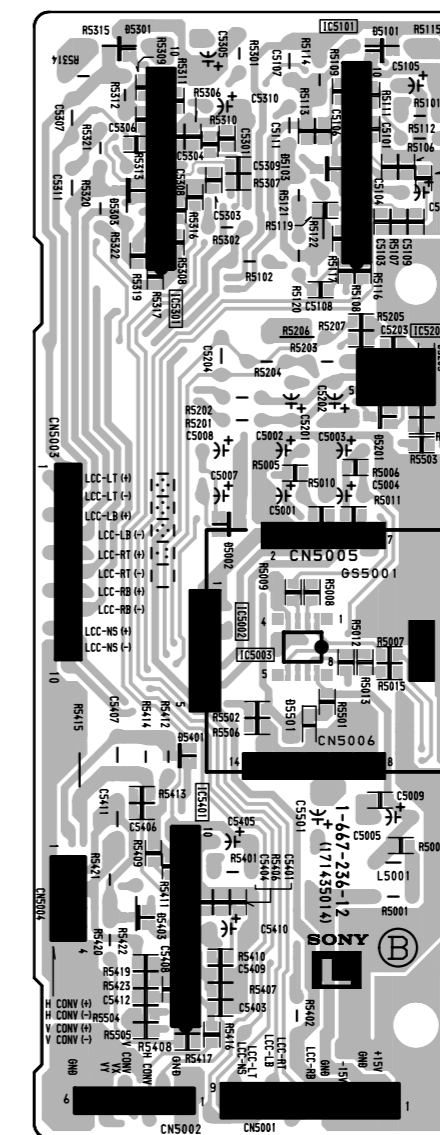

L BOARD
Terminal name of semiconductors in silk screen printed circuit (*)

Ref.	*
D5501	③
D5101, D5103, D5201, D5301, D5303, D5401, D5403	⑥
D5002	⑧

※: Refer to Terminal name of semiconductors in silk screen printed circuit (see page 5-9)

— L BOARD (Component Side) —

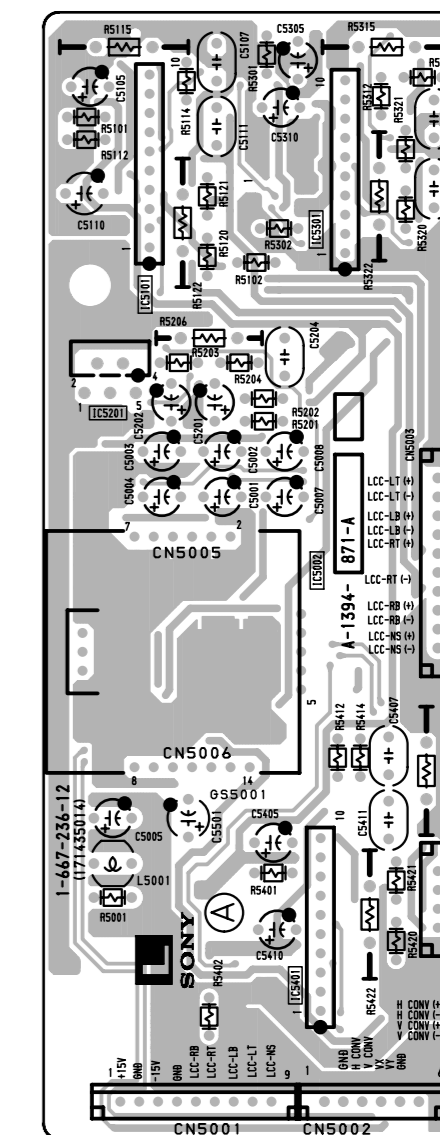

(3) Schematic Diagram of A Board

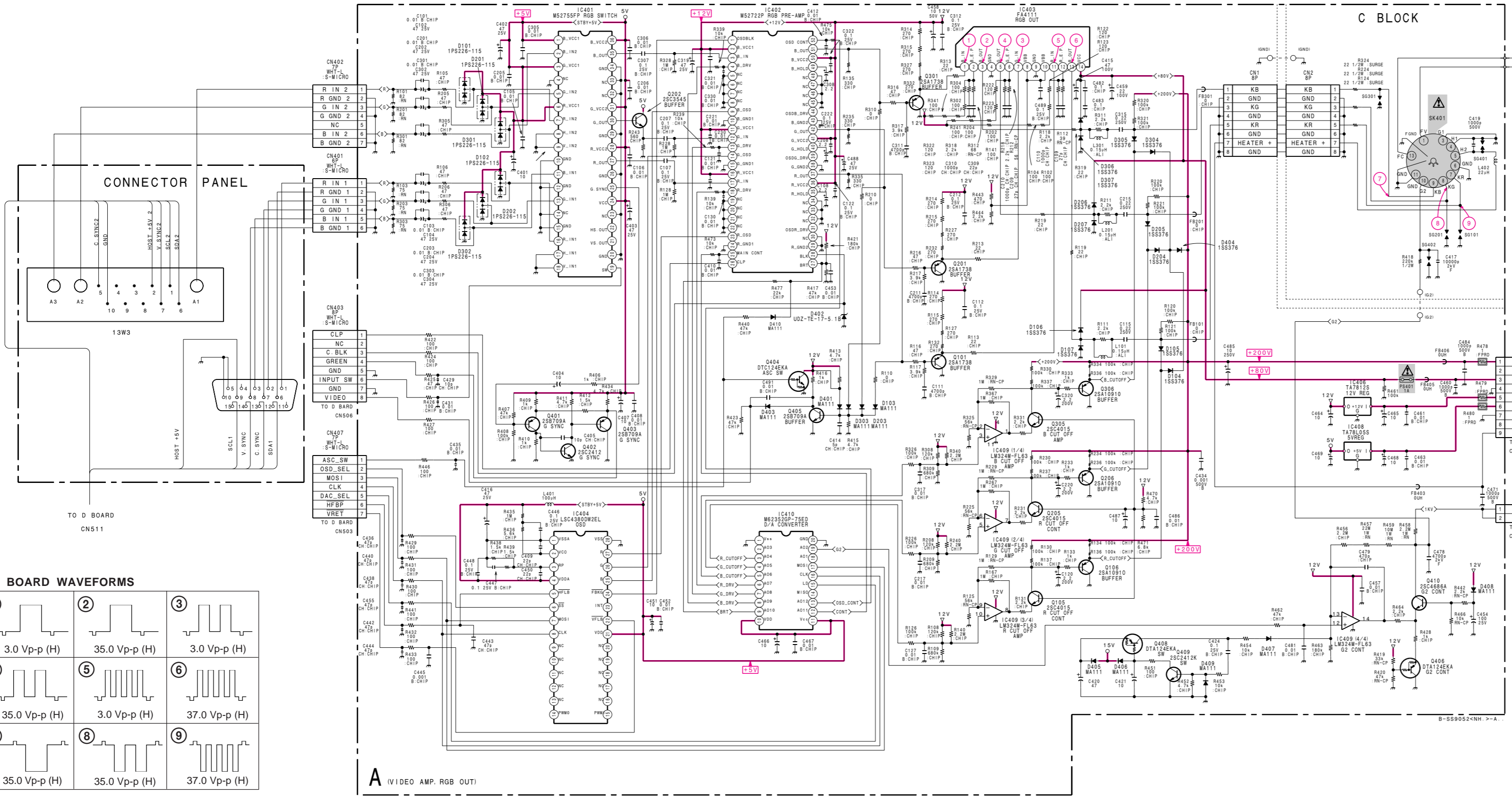

• A BOARD VOLTAGE LIST

Ref.	Pin No.	Voltage [V]	Ref.	Pin No.	Voltage [V]	
IC402	1	1.1	Q106	E	6.8	
	3	2.8		B	112.6	
	4	3.7		E	113.3	
	9	1.1		Q201	B	2.7
	12	2.8			E	3.5
	13	3.8			B	7.4
	14	1.1		Q205	C	109.9
	17	2.8			E	6.8
	18	3.9			B	7.4
	23	1.1		Q301	C	113.1
	25	3.3			E	6.8
	26	0.7			B	109.9
	27	2.4		Q305	E	110.4
28	1.2	B	2.7			
35	4.4	E	3.4			
37	2.7	Q306	B	7.4		
40	4.4		C	113.1		
42	2.7		E	6.8		
49	4.4	Q401	B	3.6		
51	2.7		C	0.7		
52	2.1		E	4.3		
IC403	1	3.4	Q406	B	7.9	
	2	2.8		E	9.0	
	3	53.6		Q410	B	9.7
	5	52.7			C	484.0
	6	2.9			E	9.1
	7	3.4		SK401	KR	87.0
	8	9.8			KG	87.0
	10	9.8			KB	87.0
	11	3.5		Q105	G2	474.0
	12	2.9			C	6.5
	13	52.3			E	

• A BOARD WAVEFORMS

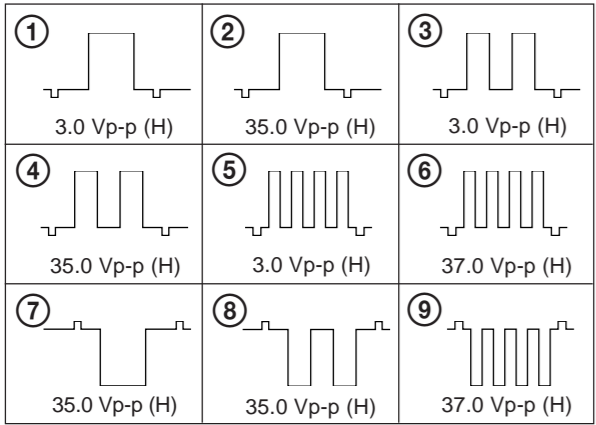

• A BOARD IC402 M52722P

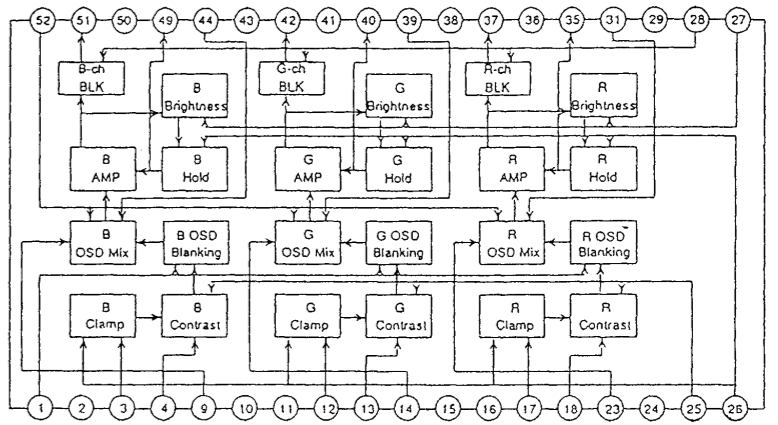

— A BOARD (Conductor Side) —

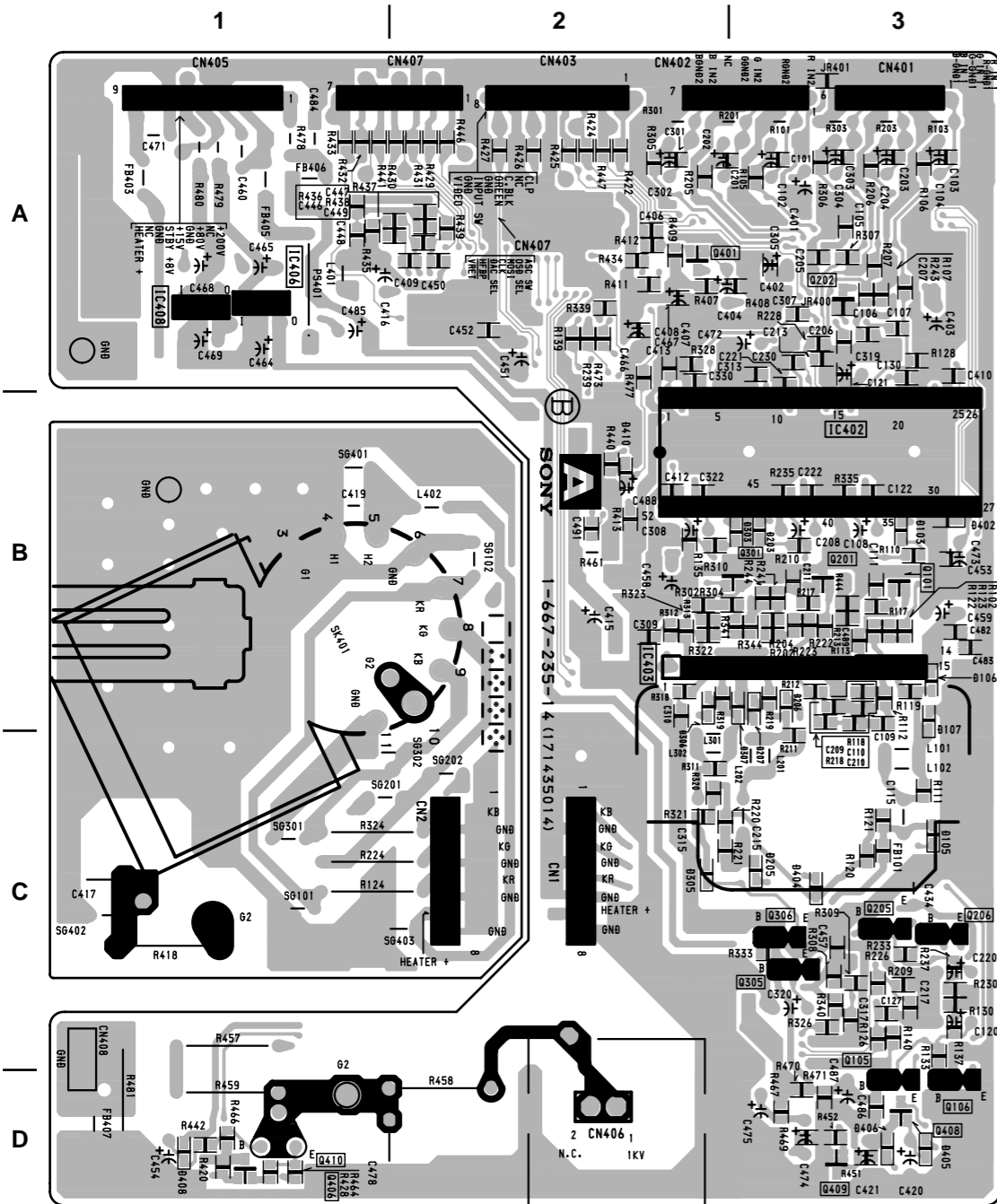

• A BOARD SEMICONDUCTOR LOCATION

IC	(Conductor Side) (Component Side)	
	IC401	A-1
IC402	B-3	B-1
IC403	B-3	B-1
IC404	A-1	A-2
IC406	A-1	A-3
IC408	A-1	A-3
IC409	A-1	C-1
IC410	A-2	A-2

TRANSISTOR	(Conductor Side) (Component Side) *	
	Q101	B-3
Q105	D-3	D-1
Q106	D-3	D-1
Q201	B-3	Ⓛ
Q202	A-3	Ⓛ
Q205	C-3	C-1
Q206	C-3	C-1
Q301	B-3	Ⓛ
Q305	C-3	C-1
Q306	C-3	C-1
Q401	A-2	Ⓛ
Q402	A-1	Ⓜ
Q403	A-2	Ⓜ
Q404	B-2	Ⓜ
Q405	B-2	Ⓜ
Q406	D-1	Ⓛ
Q407	D-1	Ⓜ
Q408	D-3	Ⓛ
Q409	D-3	Ⓛ
Q410	D-1	D-3

DIODE	(Conductor Side) (Component Side) *	
	D101	A-1
D102	A-1	Ⓟ
D103	B-3	Ⓟ
D104	B-3	Ⓟ
D105	C-3	Ⓟ
D106	B-3	Ⓟ
D107	B-3	Ⓟ
D201	A-1	Ⓟ
D202	A-1	Ⓟ
D203	B-3	Ⓟ
D204	C-1	Ⓟ
D205	C-3	Ⓟ
D206	B-3	Ⓟ
D207	B-3	Ⓟ
D301	A-2	Ⓟ
D302	A-1	Ⓟ
D303	B-3	Ⓟ
D304	C-1	Ⓟ
D305	C-2	Ⓟ
D306	B-2	Ⓟ
D307	B-3	Ⓟ
D401	B-2	Ⓟ
D402	B-3	Ⓟ
D404	C-3	Ⓟ
D405	D-3	Ⓟ
D406	D-3	Ⓟ
D407	D-1	Ⓟ
D408	D-1	Ⓟ
D409	D-1	Ⓟ
D410	B-2	Ⓟ

*: Refer to Terminal name of semiconductors in silk screen printed circuit (see page 5-9)

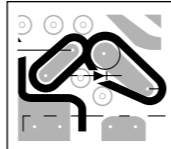

NOTE:
The circuit indicated as left contains high voltage of over 600 Vp-p. Care must be paid to prevent an electric shock in inspection or repairing.

— A BOARD (Component Side) —

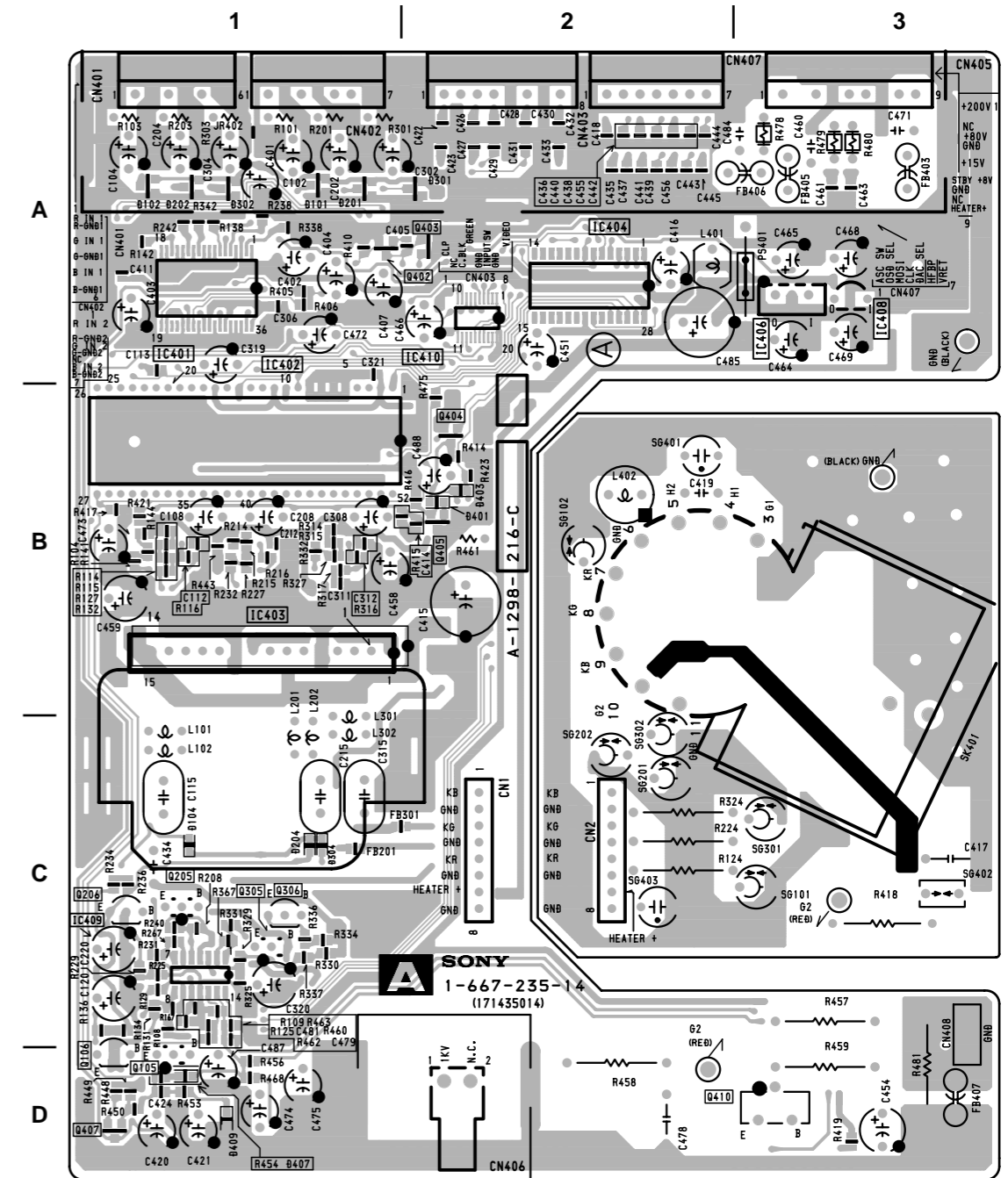

5-5. SEMICONDUCTORS

BA9756FS-E2
M62352GP-75E
M62352GP-75ED

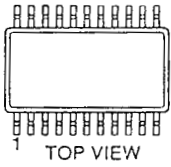

LA6510

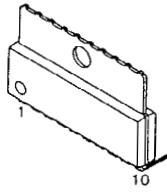

NJM4558M
TC7W04FU
 μ PC4558G2
24LC16BT/SN
24LC21A/SN

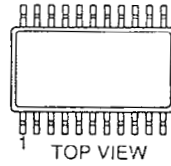

DTA114GKAT146
DTA124EKA-T146
DTC114GKA
DTC114GKAT146
DTC124EK
DTC124EKA-T146
2SA1036K-Q
2SA1036K-T-146-Q
2SA1037AK-T146-QR
2SA1037AK-T146-R
2SA1037K-T-146-QR
2SA1162G
2SA1462-Y33
2SA1738-TX
2SB709A-QRS-TX
2SC1623-L5L6
2SC2411K-CQ
2SC2411K-T-146-CQ
2SC2412K-T-146-QR
2SC3545-T43

2SA1175-HFE
2SA1309A-QRSTA
2SC2784
2SC2785-HFE
2SC3311A-QRSTA

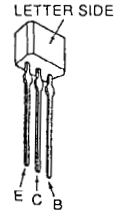

CXA2043Q

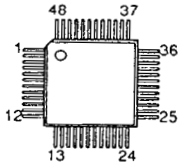

LA7841L

MARKING SIDE VIEW

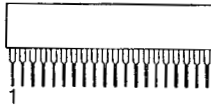

NJM78L05A
NJM78L09A
TA78L05S
TA78L09S

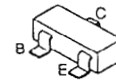
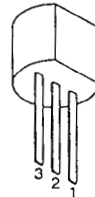

2SA1358-Y
2SC3421-Y



CXA2044M
LSC4380DW2EL

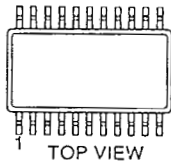

LM324M
TC74HCT04AF

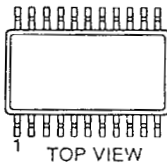

NJM78M09FA
TA7805S
TA7812S

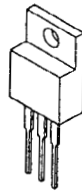

MX0841AB-F

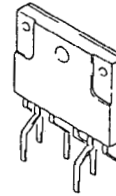

2SC2362KG-AA

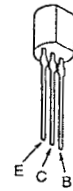

DM-60

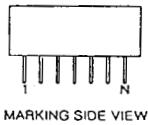

MB90553PF-G-112-BND

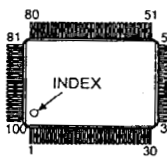

SI-3050F

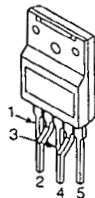

2SA1049-GR
2SC2458-YGR
2SC2459-GR



2SC3209LK

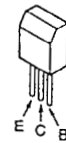

FA4111

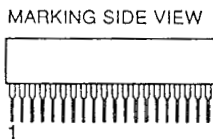

MC33262P
MM1170BFB

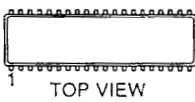

μ PC1093J



2SA1091-O
2SC2362K-G



2SC3746
2SC4686A (LBSONY)
2SJ449
2SJ449 (1)
2SJ449 (2)

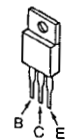

LA6500-FA

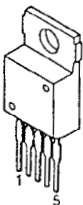

M52348FP

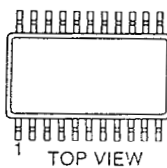

μ PC78L05J

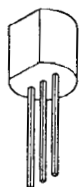

2SC4015TV2



M52722P

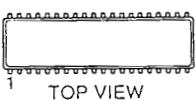

2SC5047-CA

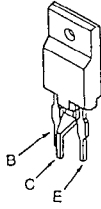

D1NL20-TR
GMA01
RD12ES-B2
RD16ES-B2
RD16ES-B3
RD18ES-B2
RD22ES-B2
RD5.1ES-B2
RD6.2ESB2
1SS119-25TD
1SS119-25
1SS120TD

FMQ-G5GS
D5L60

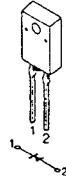

RM11A
RM11C

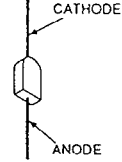

2SK1120LBSONY2
2SK2098-01MR

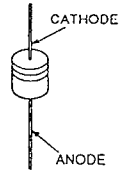
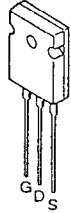

MA151WK
1SS184

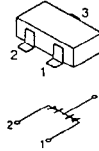

SB560

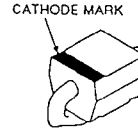

2SK2195F04

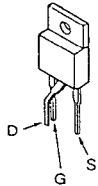

D2S4MF
D2S4MTA1

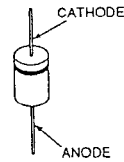

MA153
1SS226

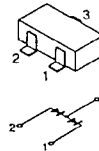

YG911S3R

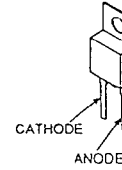

AG01A-V0
ERA91-02
S2LA20F

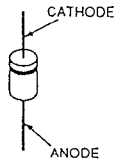

D4SBS4
D4SBS4-F
D4SBL40
D4SB60L

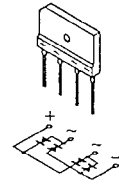

PC123F2
PC123FY2

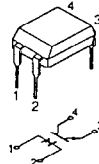

1PS226-115

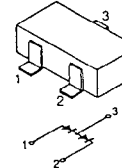

DTZ-TT11-16B
DTZ10B
DTZ13B
DTZ24B
DTZ33B
DTZ4.7C
DTZ5.1B
MA111
RD12SB2
RD5.6SB
UDZ-TE-17-10B
UDZ-TE-17-12B
UDZ-TE-17-13B
UDZ-TE-17-16B
UDZ-TE-17-24B
UDZ-TE-17-33B
UDZ-TE-17-4.7B
UDZ-TE-17-5.1B
UDZ-TE-17-5.6B
UDZ-TE-17-6.2B
UDZ-TE-17-7.5B

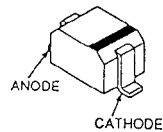

D5LC20U

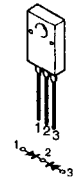

P6KE200AG23

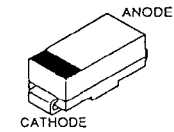
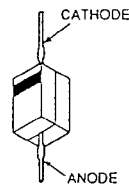

EGP20G
ERA34-10
RGP02-17EL-6433
RGP02-17PKG23
RGP02-20EG23
RGP02-20EL-6394
RGP15GPKG23
UF4005PKG23

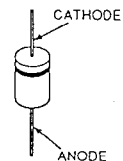

RD6.2M-B1

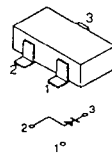

SLR-325YCT31

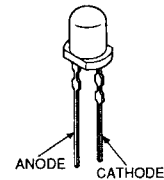

SECTION 6

EXPLODED VIEWS

- Items with no part number and no description are not stocked because they are seldom required for routine service.
- The construction parts of an assembled part are indicated with a collation number in the remark column.

- Items marked " * " are not stocked since they are seldom required for routine service. Some delay should be anticipated when ordering these items.

The components identified by shading and mark Δ are critical for safety. Replace only with part number specified.

Les composants identifiés par un trame et une marque Δ sont critiques pour la sécurité. Ne les remplacer que par une pièce portant le numéro spécifié.

6-1. CHASSIS

- \blacktriangle 7-685-647-79 +BVTP 3X10
- \blacksquare 7-685-663-71 +BVTP 4X16
- \blacktriangledown 7-685-659-71 +BVTP 4X8
- \circ 7-685-872-09 +BVTT 3X8
- \triangle 7-685-881-09 +BVTT 4X8

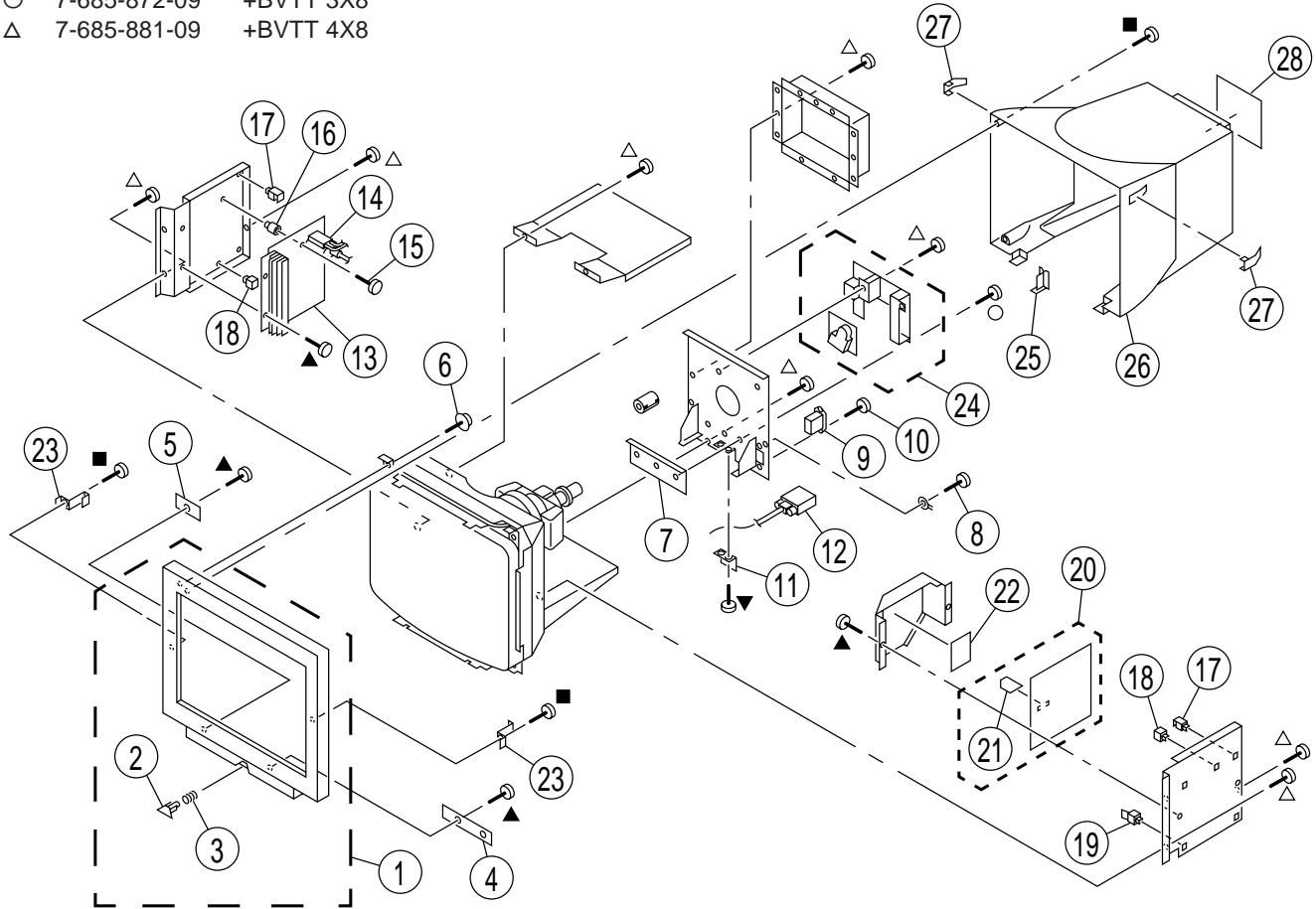

REF.NO.	PART NO.	DESCRIPTION	REMARK	REF.NO.	PART NO.	DESCRIPTION	REMARK
1	*X-4035-330-1	BEZEL ASSY [except Japan model]	2, 3	15	4-062-115-01	SCREW +P 3.5X20 TYPE2	
1	*X-4035-372-1	BEZEL ASSY [Japan model]	2, 3	16	*4-060-359-01	HOLDER, PRINTED CIRCUIT BOARD	
2	*4-063-070-01	BUTTON, POWER		17	*3-701-903-11	HOLDER, PRINTED CIRCUIT BOARD	
3	3-653-339-01	SPRING, COMPRESSION		18	*4-382-848-01	HOLDER, PRINTED CIRCUIT BOARD	
4	*8-933-298-00	H1 BOARD, COMPLETE		19	*3-703-141-00	HOLDER, PRINTED CIRCUIT BOARD	
5	*8-933-299-00	H2 BOARD, COMPLETE		20	*8-933-277-00	G BOARD, COMPLETE	21
6	4-365-808-01	SCREW (5), TAPPING		21	*8-933-269-00	GA BOARD, COMPLETE	
7	*1-694-401-11	TERMINAL BOARD ASSY, I/O		22	*4-061-694-01	SHEET, INSULATE	
8	4-389-025-01	SCREW (M4) (EXT TOOTH WASHER)		23	*4-051-566-01	HOOK (20)	
9	Δ 1-251-382-12	INLET, AC 3P (WITH NOISE FILTE)		24	*8-933-308-00	A BOARD, COMPLETE	
10	4-052-345-01	SCREW, (3X8) (+K), TAPPING		25	*4-063-077-01	COVER, PIG TAIL	
11	*4-063-072-01	HOLDER, CABLE		26	*X-4035-332-1	BUCKET ASSY, REAR	
12	1-783-476-11	CABLE (13W3P D SUB CONNECTOR)		27	*4-063-534-01	COVER, SCREW	
13	*8-933-311-00	D BOARD, COMPLETE		28	*4-063-078-02	LABLE, INFORMATION [NH/SH model]	
14	Δ X-4035-170-1	TRANSFORMER ASSY, FLYBACK (NX-4142/J1D4)		28	*4-063-322-02	LABEL, INFORMATION [K model]	
				28	*4-063-323-01	LABEL, INFORMATION [Japan model]	

6-2. PICTURE TUBE

- 7-685-663-71 +BVTP 4X16
- △ 7-685-881-09 +BVTT 4X8
- ◇ 7-685-883-01 +BVTT 4X12

The components identified by shading and mark △ are critical for safety. Replace only with part number specified.

Les composants identifiés par un tramé et une marque △ sont critiques pour la sécurité. Ne les remplacer que par une pièce portant le numéro spécifié.

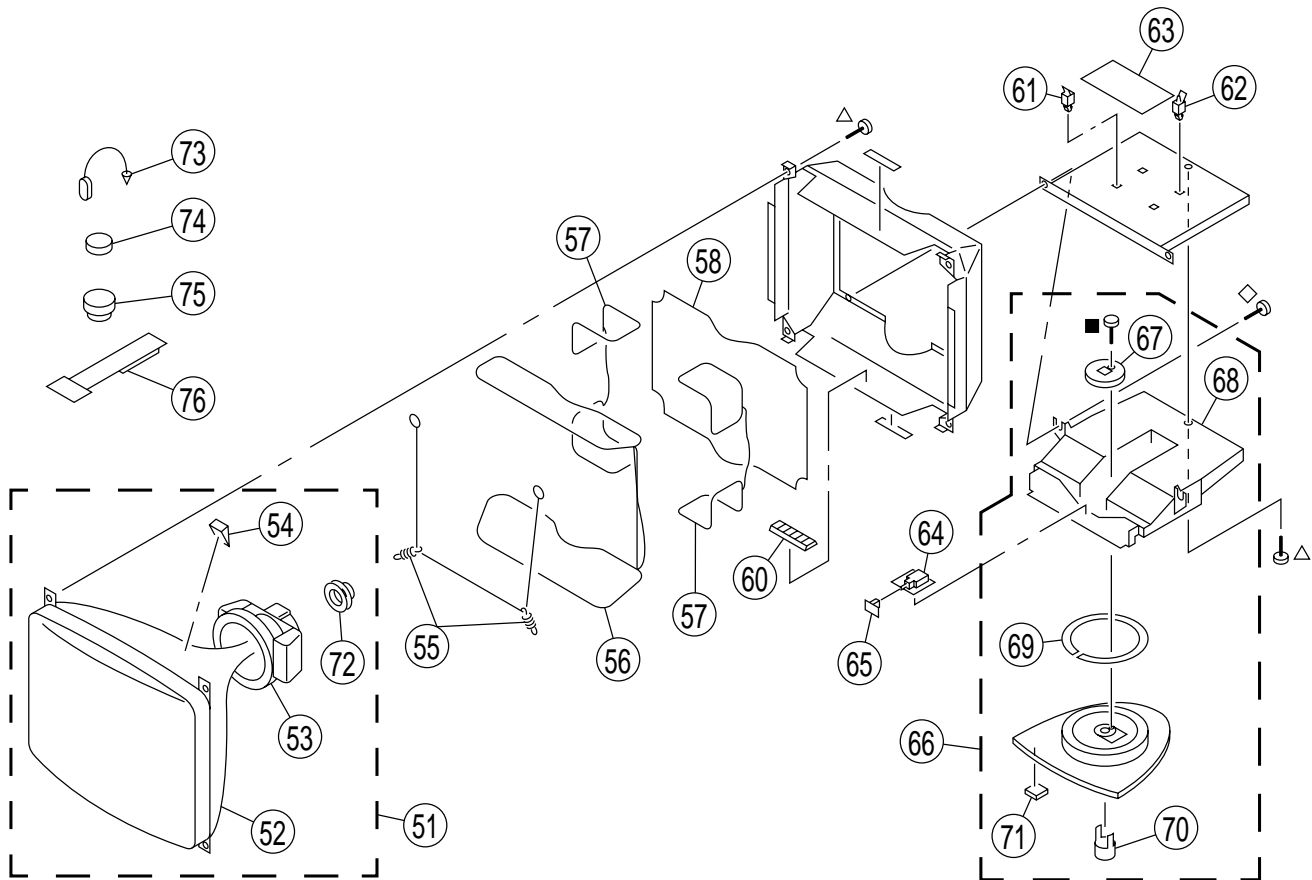

REF.NO.	PART NO.	DESCRIPTION	REMARK	REF.NO.	PART NO.	DESCRIPTION	REMARK
51	△ 8-738-791-81	ITC ASSY (21SRG-R1)	52-54, 72 [except SH model]	63	* 8-933-297-00	L BOARD, COMPLETE	
51	△ 8-738-792-81	ITC ASSY (21SRG-RS1)	52-54, 72 [SH model]	64	* 8-933-279-00	J BOARD, COMPLETE	
52	△ 8-738-796-05	PICTURE TUBE (21SRG)	[except SH model]	65	* 4-394-972-21	CAP, POWER	
52	△ 8-738-799-05	PICTURE TUBE (21SRG) [SH model]		66	* X-4035-331-1	STAND ASSY	67-71
53	△ 8-451-493-31	DEFLECTION YOKE (Y21SRL-M3)		67	4-061-396-01	STOPPER (A)	
54	4-050-492-01	SPACER, DY		68	* 4-063-082-01	COVER, BOTTOM	
55	* 4-047-316-01	SPRING, TENSION		69	4-060-339-01	RING, TILT SWIVEL	
56	△ 1-416-437-11	COIL, DEMAGNETIC		70	4-041-621-02	STOPPER (B)	
57	△ 1-416-140-21	COIL, LANDING CORRECTION		71	* 4-063-071-01	FOOT	
58	△ 1-416-438-21	COIL, LANDING CORRECTION		72	△ 1-452-932-11	NECK ASSEMBLY	
60	4-062-670-02	SPACER, PICTURE TUBE		73	4-308-870-00	CLIP, LEAD WIRE	
61	* 4-321-929-00	HOLDER, PRINTED CIRCUIT BOARD		74	1-452-032-00	MAGNET, DISK; 10mmφ	
62	* 3-703-141-00	HOLDER, PRINTED CIRCUIT BOARD		75	1-452-094-00	MAGNET, ROTATABLE DISK; 15mmφ	
				76	4-059-493-01	PERMALLOY (90), CONV. CORRECT	

6-3. PACKING MATERIALS

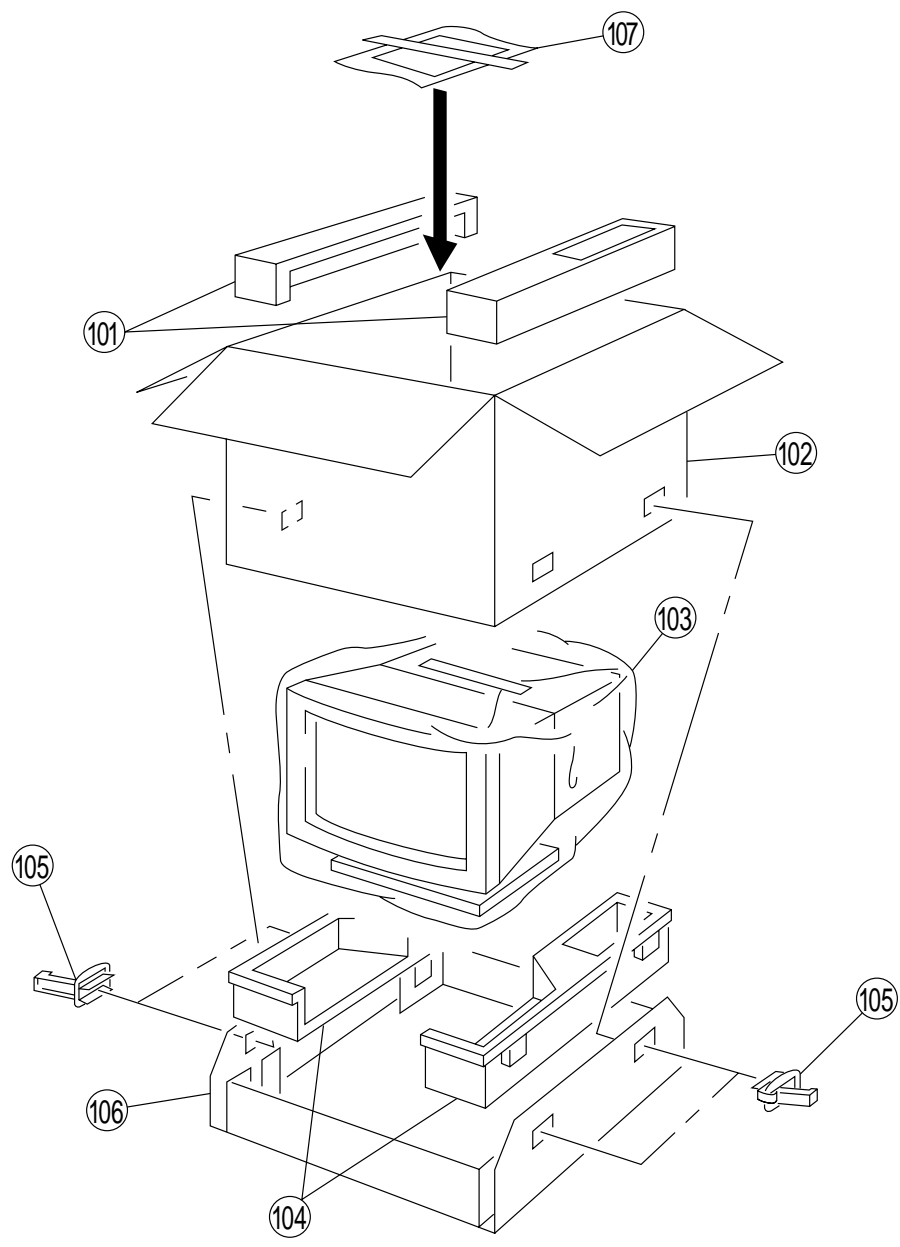

REF.NO.	PART NO.	DESCRIPTION	REMARK	REF.NO.	PART NO.	DESCRIPTION	REMARK
101	* 4-063-141-01	CUSHION (UPPER) (ASSY)		105	4-396-077-01	JOINT	
102	* 4-063-140-01	INDIVIDUAL CARTON		106	* 4-061-815-01	TRAY	
			[except Japan model]	107	* 3-862-094-12	MANUAL, INSTRUCTION	[except K model]
102	* 4-063-622-01	INDIVIDUAL CARTON	[Japan model]	107	* 3-862-094-22	MANUAL, INSTRUCTION	[K model]
103	* 4-041-927-32	BAG, POLYETHYLENE					
104	* 4-063-142-01	CUSHION (LOWER) (ASSY)					

A

ELECTRICAL PARTS LIST

NOTE:

The components identified by shading and mark \triangle are critical for safety. Replace only with part number specified.

Les composants identifiés par un tramé et une marque \triangle sont critiques pour la sécurité. Ne les remplacer que par une pièce portant le numéro spécifié.

When indicating parts by reference number, please include the board name.

• All variable and adjustable resistors have characteristic curve B, unless otherwise noted.

RESISTORS

• All resistors are in ohms
• F : nonflammable

• Items marked " * " are not stocked since they are seldom required for routine service. Some delay should be anticipated when ordering these items.

CAPACITORS

MF : μ F
UH : μ H

REF.NO.	PART NO.	DESCRIPTION	REMARK	REF.NO.	PART NO.	DESCRIPTION	REMARK
		*8-933-308-00 A BOARD, COMPLETE *****					
		4-382-854-11 SCREW (M3X10), P, SW (+) (IC403)					
		<CAPACITOR>					
C101	1-164-232-11	CERAMIC CHIP 0.01MF	10% 50V	C230	1-164-232-11	CERAMIC CHIP 0.01MF	10% 50V
C102	1-104-664-11	ELECT 47MF	20% 25V	C301	1-164-232-11	CERAMIC CHIP 0.01MF	10% 50V
C103	1-164-232-11	CERAMIC CHIP 0.01MF	10% 50V	C302	1-104-664-11	ELECT 47MF	20% 25V
C104	1-104-664-11	ELECT 47MF	20% 25V	C303	1-164-232-11	CERAMIC CHIP 0.01MF	10% 50V
C105	1-164-232-11	CERAMIC CHIP 0.01MF	10% 50V	C304	1-104-664-11	ELECT 47MF	20% 25V
C106	1-164-232-11	CERAMIC CHIP 0.01MF	10% 50V	C305	1-164-232-11	CERAMIC CHIP 0.01MF	10% 50V
C107	1-164-004-11	CERAMIC CHIP 0.1MF	10% 25V	C306	1-164-232-11	CERAMIC CHIP 0.01MF	10% 50V
C108	1-107-903-11	ELECT 2.2MF	20% 50V	C307	1-164-004-11	CERAMIC CHIP 0.1MF	10% 25V
C109	1-163-237-11	CERAMIC CHIP 27PF	5% 50V	C308	1-107-903-11	ELECT 2.2MF	20% 50V
C110	1-163-275-11	CERAMIC CHIP 0.001MF	5% 50V	C309	1-163-235-11	CERAMIC CHIP 22PF	5% 50V
C111	1-163-017-00	CERAMIC CHIP 0.0047MF	10% 50V	C310	1-163-275-11	CERAMIC CHIP 0.001MF	5% 50V
C112	1-164-004-11	CERAMIC CHIP 0.1MF	10% 25V	C311	1-163-017-00	CERAMIC CHIP 0.0047MF	10% 50V
C115	1-104-514-11	FILM 0.22MF	10% 250V	C312	1-164-004-11	CERAMIC CHIP 0.1MF	10% 25V
C120	1-107-949-11	ELECT 2.2MF	20% 200V	C315	1-104-514-11	FILM 0.22MF	10% 250V
C121	1-164-232-11	CERAMIC CHIP 0.01MF	10% 50V	C317	1-164-232-11	CERAMIC CHIP 0.01MF	10% 50V
C122	1-164-004-11	CERAMIC CHIP 0.1MF	10% 25V	C319	1-107-888-11	ELECT 47MF	20% 25V
C127	1-164-232-11	CERAMIC CHIP 0.01MF	10% 50V	C320	1-107-949-11	ELECT 2.2MF	20% 200V
C130	1-164-232-11	CERAMIC CHIP 0.01MF	10% 50V	C321	1-164-232-11	CERAMIC CHIP 0.01MF	10% 50V
C201	1-164-232-11	CERAMIC CHIP 0.01MF	10% 50V	C322	1-164-004-11	CERAMIC CHIP 0.1MF	10% 25V
C202	1-104-664-11	ELECT 47MF	20% 25V	C330	1-164-232-11	CERAMIC CHIP 0.01MF	10% 50V
C203	1-164-232-11	CERAMIC CHIP 0.01MF	10% 50V	C401	1-126-964-11	ELECT 10MF	20% 50V
C204	1-104-664-11	ELECT 47MF	20% 25V	C402	1-104-664-11	ELECT 47MF	20% 25V
C205	1-164-232-11	CERAMIC CHIP 0.01MF	10% 50V	C403	1-104-664-11	ELECT 47MF	20% 25V
C206	1-164-232-11	CERAMIC CHIP 0.01MF	10% 50V	C404	1-126-964-11	ELECT 10MF	20% 50V
C207	1-164-004-11	CERAMIC CHIP 0.1MF	10% 25V	C405	1-163-227-11	CERAMIC CHIP 10PF	0.5PF 50V
C208	1-107-903-11	ELECT 2.2MF	20% 50V	C407	1-126-964-11	ELECT 10MF	20% 50V
C209	1-163-237-11	CERAMIC CHIP 27PF	5% 50V	C408	1-164-232-11	CERAMIC CHIP 0.01MF	10% 50V
C210	1-163-275-11	CERAMIC CHIP 0.001MF	5% 50V	C409	1-163-235-11	CERAMIC CHIP 22PF	5% 50V
C211	1-163-017-00	CERAMIC CHIP 0.0047MF	10% 50V	C410	1-164-232-11	CERAMIC CHIP 0.01MF	10% 50V
C212	1-164-004-11	CERAMIC CHIP 0.1MF	10% 25V	C412	1-164-232-11	CERAMIC CHIP 0.01MF	10% 50V
C215	1-104-514-11	FILM 0.22MF	10% 250V	C414	1-163-222-91	CERAMIC CHIP 5PF	5% 50V
C217	1-164-232-11	CERAMIC CHIP 0.01MF	10% 50V	C415	1-128-562-11	ELECT 47MF	20% 100V
C220	1-107-949-11	ELECT 2.2MF	20% 200V	C416	1-104-664-11	ELECT 47MF	20% 25V
C221	1-164-232-11	CERAMIC CHIP 0.01MF	10% 50V	C417	1-115-349-51	CERAMIC 0.01MF	2KV
C222	1-164-004-11	CERAMIC CHIP 0.1MF	10% 25V	C419	1-162-318-11	CERAMIC 0.001MF	10% 500V
				C420	1-126-967-11	ELECT 47MF	20% 50V
				C421	1-126-964-11	ELECT 10MF	20% 50V
				C424	1-164-004-11	CERAMIC CHIP 0.1MF	10% 25V
				C429	1-163-227-11	CERAMIC CHIP 10PF	0.5PF 50V
				C431	1-164-232-11	CERAMIC CHIP 0.01MF	10% 50V
				C434	1-162-318-11	CERAMIC 0.001MF	10% 500V



Les composants identifiés par un tramé et une marque Δ sont critiques pour la sécurité. Ne les remplacer que par une pièce portant le numéro spécifié.

The components identified by shading and mark Δ are critical for safety. Replace only with part number specified.

REF.NO.	PART NO.	DESCRIPTION	REMARK	REF.NO.	PART NO.	DESCRIPTION	REMARK
L301	1-412-478-11	INDUCTOR	0.15UH	R126	1-216-097-91	RES,CHIP	100K 5% 1/10W
L401	1-408-421-00	INDUCTOR	100UH	R127	1-216-035-00	RES,CHIP	270 5% 1/10W
L402	1-412-529-11	INDUCTOR	22UH	R128	1-216-121-91	RES,CHIP	1M 5% 1/10W
				R129	1-218-776-11	METAL CHIP	1M 0.50%1/10W
	<IC LINK>			R130	1-216-097-91	RES,CHIP	100K 5% 1/10W
	PS401 Δ 1-533-590-31	LINK, IC (1A/90V AC, 60V DC)		R131	1-216-057-00	RES,CHIP	2.2K 5% 1/10W
				R132	1-216-035-00	RES,CHIP	270 5% 1/10W
	<TRANSISTOR>			R133	1-216-049-91	RES,CHIP	1K 5% 1/10W
Q101	8-729-112-65	TRANSISTOR 2SA1462-Y33		R134	1-216-097-91	RES,CHIP	100K 5% 1/10W
Q105	8-729-041-66	TRANSISTOR 2SC4015TV2		R135	1-216-037-00	RES,CHIP	330 5% 1/10W
Q106	8-729-200-17	TRANSISTOR 2SA1091-O		R136	1-216-097-91	RES,CHIP	100K 5% 1/10W
Q201	8-729-112-65	TRANSISTOR 2SA1462-Y33		R137	1-216-097-91	RES,CHIP	100K 5% 1/10W
Q202	8-729-107-31	TRANSISTOR 2SC3545-T43		R139	1-216-073-00	RES,CHIP	10K 5% 1/10W
				R140	1-216-129-00	RES,CHIP	2.2M 5% 1/10W
Q205	8-729-041-66	TRANSISTOR 2SC4015TV2		R141	1-216-025-91	RES,CHIP	100 5% 1/10W
Q206	8-729-200-17	TRANSISTOR 2SA1091-O		R144	1-216-295-91	SHORT	0
Q301	8-729-112-65	TRANSISTOR 2SA1462-Y33		R167	1-216-121-91	RES,CHIP	1M 5% 1/10W
Q305	8-729-041-66	TRANSISTOR 2SC4015TV2		R201	1-215-395-00	METAL	82 1% 1/4W
Q306	8-729-200-17	TRANSISTOR 2SA1091-O		R202	1-216-025-91	RES,CHIP	100 5% 1/10W
				R203	1-215-395-00	METAL	82 1% 1/4W
Q401	8-729-216-22	TRANSISTOR 2SA1162-G		R204	1-216-025-91	RES,CHIP	100 5% 1/10W
Q402	8-729-120-28	TRANSISTOR 2SC1623-L5L6					
Q403	8-729-216-22	TRANSISTOR 2SA1162-G		R205	1-216-017-91	RES,CHIP	47 5% 1/10W
Q404	8-729-901-00	TRANSISTOR DTC124EK		R206	1-216-017-91	RES,CHIP	47 5% 1/10W
Q405	8-729-216-22	TRANSISTOR 2SA1162-G		R208	1-216-099-00	RES,CHIP	120K 5% 1/10W
				R209	1-216-117-00	RES,CHIP	680K 5% 1/10W
Q406	8-729-027-31	TRANSISTOR DTA124EKA-T146		R210	1-216-295-91	SHORT	0
Q408	8-729-027-31	TRANSISTOR DTA124EKA-T146					
Q409	8-729-120-28	TRANSISTOR 2SC1623-L5L6		R211	1-216-057-00	RES,CHIP	2.2K 5% 1/10W
Q410	8-729-020-07	TRANSISTOR 2SC4686A(LBSONY)		R212	1-216-621-11	METAL CHIP	56 0.50%1/10W
				R213	1-216-009-00	RES,CHIP	22 5% 1/10W
	<RESISTOR>			R214	1-216-035-00	RES,CHIP	270 5% 1/10W
R101	1-215-395-00	METAL	82 1% 1/4W	R215	1-216-035-00	RES,CHIP	270 5% 1/10W
R102	1-216-025-91	RES,CHIP	100 5% 1/10W				
R103	1-215-395-00	METAL	82 1% 1/4W	R216	1-216-017-91	RES,CHIP	47 5% 1/10W
R104	1-216-025-91	RES,CHIP	100 5% 1/10W	R217	1-216-063-91	RES,CHIP	3.9K 5% 1/10W
R105	1-216-017-91	RES,CHIP	47 5% 1/10W	R218	1-216-057-00	RES,CHIP	2.2K 5% 1/10W
				R219	1-216-009-00	RES,CHIP	22 5% 1/10W
R106	1-216-017-91	RES,CHIP	47 5% 1/10W	R220	1-216-097-91	RES,CHIP	100K 5% 1/10W
R108	1-216-099-00	RES,CHIP	120K 5% 1/10W	R221	1-216-097-91	RES,CHIP	100K 5% 1/10W
R109	1-216-117-00	RES,CHIP	680K 5% 1/10W	R222	1-216-027-00	RES,CHIP	120 5% 1/10W
R110	1-216-295-91	SHORT	0	R223	1-216-027-00	RES,CHIP	120 5% 1/10W
R111	1-216-057-00	RES,CHIP	2.2K 5% 1/10W	R224	1-219-497-11	CARBON	22 5% 1/2W
				R225	1-216-693-11	METAL CHIP	56K 0.50%1/10W
R112	1-216-617-11	METAL CHIP	39 0.50%1/10W				
R113	1-216-009-00	RES,CHIP	22 5% 1/10W	R226	1-216-097-91	RES,CHIP	100K 5% 1/10W
R114	1-216-035-00	RES,CHIP	270 5% 1/10W	R227	1-216-035-00	RES,CHIP	270 5% 1/10W
R115	1-216-035-00	RES,CHIP	270 5% 1/10W	R228	1-216-121-91	RES,CHIP	1M 5% 1/10W
R116	1-216-017-91	RES,CHIP	47 5% 1/10W	R229	1-218-776-11	METAL CHIP	1M 0.50%1/10W
				R230	1-216-097-91	RES,CHIP	100K 5% 1/10W
R117	1-216-063-91	RES,CHIP	3.9K 5% 1/10W				
R118	1-216-057-00	RES,CHIP	2.2K 5% 1/10W	R231	1-216-057-00	RES,CHIP	2.2K 5% 1/10W
R119	1-216-009-00	RES,CHIP	22 5% 1/10W	R232	1-216-035-00	RES,CHIP	270 5% 1/10W
R120	1-216-097-91	RES,CHIP	100K 5% 1/10W	R233	1-216-049-91	RES,CHIP	1K 5% 1/10W
R121	1-216-097-91	RES,CHIP	100K 5% 1/10W	R234	1-216-097-91	RES,CHIP	100K 5% 1/10W
				R235	1-216-037-00	RES,CHIP	330 5% 1/10W
R122	1-216-027-00	RES,CHIP	120 5% 1/10W				
R123	1-216-027-00	RES,CHIP	120 5% 1/10W	R236	1-216-097-91	RES,CHIP	100K 5% 1/10W
R124	1-219-497-11	CARBON	22 5% 1/2W	R237	1-216-097-91	RES,CHIP	100K 5% 1/10W
R125	1-216-693-11	METAL CHIP	56K 0.50%1/10W	R239	1-216-073-00	RES,CHIP	10K 5% 1/10W
				R240	1-216-129-00	RES,CHIP	2.2M 5% 1/10W



REF.NO.	PART NO.	DESCRIPTION	REMARK	REF.NO.	PART NO.	DESCRIPTION	REMARK
R241	1-216-025-91	RES,CHIP	100 5% 1/10W	R417	1-216-089-91	RES,CHIP	47K 5% 1/10W
R243	1-216-043-91	RES,CHIP	560 5% 1/10W	R418	1-260-127-11	CARBON	220K 5% 1/2W
R244	1-216-295-91	SHORT	0	R419	1-216-687-11	METAL CHIP	33K 0.50%1/10W
R267	1-216-121-91	RES,CHIP	1M 5% 1/10W	R420	1-216-691-11	METAL CHIP	47K 0.50%1/10W
R301	1-215-395-00	METAL	82 1% 1/4W	R421	1-216-103-00	RES,CHIP	180K 5% 1/10W
R302	1-216-025-91	RES,CHIP	100 5% 1/10W	R422	1-216-025-91	RES,CHIP	100 5% 1/10W
R303	1-215-395-00	METAL	82 1% 1/4W	R423	1-216-089-91	RES,CHIP	47K 5% 1/10W
R304	1-216-025-91	RES,CHIP	100 5% 1/10W	R424	1-216-025-91	RES,CHIP	100 5% 1/10W
R305	1-216-017-91	RES,CHIP	47 5% 1/10W	R425	1-216-017-91	RES,CHIP	47 5% 1/10W
R306	1-216-017-91	RES,CHIP	47 5% 1/10W	R426	1-216-025-91	RES,CHIP	100 5% 1/10W
R308	1-216-099-00	RES,CHIP	120K 5% 1/10W	R427	1-216-025-91	RES,CHIP	100 5% 1/10W
R309	1-216-117-00	RES,CHIP	680K 5% 1/10W	R428	1-216-049-91	RES,CHIP	1K 5% 1/10W
R310	1-216-295-91	SHORT	0	R429	1-216-025-91	RES,CHIP	100 5% 1/10W
R311	1-216-057-00	RES,CHIP	2.2K 5% 1/10W	R430	1-216-025-91	RES,CHIP	100 5% 1/10W
R312	1-216-623-11	METAL CHIP	68 0.50%1/10W	R431	1-216-025-91	RES,CHIP	100 5% 1/10W
R313	1-216-009-00	RES,CHIP	22 5% 1/10W	R432	1-216-025-91	RES,CHIP	100 5% 1/10W
R314	1-216-035-00	RES,CHIP	270 5% 1/10W	R433	1-216-025-91	RES,CHIP	100 5% 1/10W
R315	1-216-035-00	RES,CHIP	270 5% 1/10W	R434	1-216-065-00	RES,CHIP	4.7K 5% 1/10W
R316	1-216-017-91	RES,CHIP	47 5% 1/10W	R435	1-216-121-91	RES,CHIP	1M 5% 1/10W
R317	1-216-063-91	RES,CHIP	3.9K 5% 1/10W	R436	1-216-067-00	RES,CHIP	5.6K 5% 1/10W
R318	1-216-057-00	RES,CHIP	2.2K 5% 1/10W	R438	1-216-053-00	RES,CHIP	1.5K 5% 1/10W
R319	1-216-009-00	RES,CHIP	22 5% 1/10W	R439	1-216-053-00	RES,CHIP	1.5K 5% 1/10W
R320	1-216-097-91	RES,CHIP	100K 5% 1/10W	R440	1-216-089-91	RES,CHIP	47K 5% 1/10W
R321	1-216-097-91	RES,CHIP	100K 5% 1/10W	R441	1-216-025-91	RES,CHIP	100 5% 1/10W
R322	1-216-027-00	RES,CHIP	120 5% 1/10W	R442	1-216-659-11	METAL CHIP	2.2K 0.50%1/10W
R323	1-216-027-00	RES,CHIP	120 5% 1/10W	R443	1-216-041-00	RES,CHIP	470 5% 1/10W
R324	1-219-497-11	CARBON	22 5% 1/2W	R444	1-216-057-00	RES,CHIP	2.2K 5% 1/10W
R325	1-216-693-11	METAL CHIP	56K 0.50%1/10W	R446	1-216-025-91	RES,CHIP	100 5% 1/10W
R326	1-216-097-91	RES,CHIP	100K 5% 1/10W	R451	1-216-025-91	RES,CHIP	100 5% 1/10W
R327	1-216-035-00	RES,CHIP	270 5% 1/10W	R452	1-216-065-00	RES,CHIP	4.7K 5% 1/10W
R328	1-216-121-91	RES,CHIP	1M 5% 1/10W	R453	1-216-073-00	RES,CHIP	10K 5% 1/10W
R329	1-218-776-11	METAL CHIP	1M 0.50%1/10W	R454	1-216-073-00	RES,CHIP	10K 5% 1/10W
R330	1-216-097-91	RES,CHIP	100K 5% 1/10W	R456	1-216-129-00	RES,CHIP	2.2M 5% 1/10W
R331	1-216-057-00	RES,CHIP	2.2K 5% 1/10W	R457	1-219-621-91	METAL	22M 10% 1/4W
R332	1-216-035-00	RES,CHIP	270 5% 1/10W	R458	1-211-885-21	METAL	2.2M 5% 1W
R333	1-216-049-91	RES,CHIP	1K 5% 1/10W	R459	1-219-720-11	METAL	10M 5% 1W
R334	1-216-097-91	RES,CHIP	100K 5% 1/10W	R461	1-249-441-11	CARBON	100K 5% 1/4W
R335	1-216-037-00	RES,CHIP	330 5% 1/10W	R462	1-216-089-91	RES,CHIP	47K 5% 1/10W
R336	1-216-097-91	RES,CHIP	100K 5% 1/10W	R463	1-216-103-00	RES,CHIP	180K 5% 1/10W
R337	1-216-097-91	RES,CHIP	100K 5% 1/10W	R464	1-216-057-00	RES,CHIP	2.2K 5% 1/10W
R339	1-216-073-00	RES,CHIP	10K 5% 1/10W	R466	1-216-675-11	METAL CHIP	10K 0.50%1/10W
R340	1-216-129-00	RES,CHIP	2.2M 5% 1/10W	R470	1-216-065-00	RES,CHIP	4.7K 5% 1/10W
R341	1-216-025-91	RES,CHIP	100 5% 1/10W	R471	1-216-069-00	RES,CHIP	6.8K 5% 1/10W
R344	1-216-295-91	SHORT	0	R473	1-216-073-00	RES,CHIP	10K 5% 1/10W
R367	1-216-121-91	RES,CHIP	1M 5% 1/10W	R475	1-216-073-00	RES,CHIP	10K 5% 1/10W
R406	1-216-049-91	RES,CHIP	1K 5% 1/10W	R477	1-216-081-00	RES,CHIP	22K 5% 1/10W
R407	1-216-089-91	RES,CHIP	47K 5% 1/10W	R478	1-249-381-11	CARBON	1 5% 1/4W F
R408	1-216-097-91	RES,CHIP	100K 5% 1/10W	R479	1-249-381-11	CARBON	1 5% 1/4W F
R409	1-216-049-91	RES,CHIP	1K 5% 1/10W	R480	1-249-381-11	CARBON	1 5% 1/4W F
R410	1-216-049-91	RES,CHIP	1K 5% 1/10W				
R411	1-216-065-00	RES,CHIP	4.7K 5% 1/10W				
R412	1-216-053-00	RES,CHIP	1.5K 5% 1/10W				
R413	1-216-065-00	RES,CHIP	4.7K 5% 1/10W				
R415	1-216-065-00	RES,CHIP	4.7K 5% 1/10W				
R416	1-216-049-91	RES,CHIP	1K 5% 1/10W				
<SPARK GAP>							
				SG101	1-517-499-21	GAP, SPARK	
				SG201	1-517-499-21	GAP, SPARK	
				SG301	1-517-499-21	GAP, SPARK	

GDM-5010PT



Les composants identifiés par un tramé et une marque Δ sont critiques pour la sécurité. Ne les remplacer que par une pièce portant le numéro spécifié.

The components identified by shading and mark Δ are critical for safety. Replace only with part number specified.

REF.NO.	PART NO.	DESCRIPTION	REMARK	REF.NO.	PART NO.	DESCRIPTION	REMARK
SG401	1-519-526-11	LAMP, NEON		R7512	1-216-089-91	RES,CHIP 47K	5% 1/10W
SG402	1-519-422-11	GAP, SPARK		R7513	1-216-093-00	RES,CHIP 68K	5% 1/10W
<SOCKET>							
SK401 Δ 1-251-640-11 SOCKET, PICTURE TUBE							
*****				*****			
* 8-933-269-00 GA BOARD, COMPLETE *****				* 8-933-277-00 G BOARD, COMPLETE *****			
*****				*****			
<CAPACITOR>				<CAPACITOR>			
C7501	1-164-232-11	CERAMIC CHIP 0.01MF	10% 50V	C601 Δ	1-113-900-51	CERAMIC 470PF	10% 250V
C7502	1-136-169-00	FILM 0.22MF	5% 50V	C602 Δ	1-113-900-51	CERAMIC 470PF	10% 250V
C7503	1-163-009-11	CERAMIC CHIP 0.001MF	10% 50V	C603 Δ	1-107-533-51	FILM 1MF	20% 250V
C7504	1-136-165-00	FILM 0.1MF	5% 50V	C604 Δ	1-107-533-51	FILM 1MF	20% 250V
C7505	1-164-004-11	CERAMIC CHIP 0.1MF	10% 25V	C605 Δ	1-113-926-91	CERAMIC 0.0047MF	250V
C7506	1-164-004-11	CERAMIC CHIP 0.1MF	10% 25V	C606 Δ	1-113-926-91	CERAMIC 0.0047MF	250V
<CONNECTOR>				<CONNECTOR>			
CN7501*1-774-512-11CONNECTOR, BPARD TO BOARD 10P				C607 1-113-900-11 CERAMIC 470PF 10% 250V			
<DIODE>				<DIODE>			
D7501	8-719-110-57	ZENER DIODE RD22ESB2		C610	1-137-479-11	FILM 1MF	10% 400V
D7502	8-719-911-19	DIODE 1SS119-25		C611	1-117-849-11	ELECT 330MF	20% 450V
<IC>				<IC>			
IC7501 8-759-482-62 IC MC33262P				C612 1-126-959-11 ELECT 0.47MF 20% 50V			
<TRANSISTOR>				<TRANSISTOR>			
Q7501	8-729-026-49	TRANSISTOR 2SA1037AK-T146-R		C616	1-107-888-11	ELECT 47MF	20% 25V
Q7502	8-729-120-28	TRANSISTOR 2SC1623-L5L6		C640	1-165-127-11	CERAMIC 470PF	10% 500V
Q7503	8-729-120-28	TRANSISTOR 2SC1623-L5L6		C641	1-165-127-11	CERAMIC 470PF	10% 500V
Q7504	8-729-026-49	TRANSISTOR 2SA1037AK-T146-R		C642	1-136-171-00	FILM 0.33MF	5% 50V
<RESISTOR>				<RESISTOR>			
R7501	1-216-025-91	RES,CHIP 100	5% 1/10W	C643	1-136-171-00	FILM 0.33MF	5% 50V
R7502	1-216-073-00	RES,CHIP 10K	5% 1/10W	C644	1-165-127-11	CERAMIC 470PF	10% 500V
R7503	1-216-041-00	RES,CHIP 470	5% 1/10W	C645	1-136-167-00	FILM 0.15MF	5% 50V
R7504	1-216-675-11	METAL CHIP 10K	0.50% 1/10W	C646	1-136-167-00	FILM 0.15MF	5% 50V
R7505	1-216-673-11	METAL CHIP 8.2K	0.50% 1/10W	C647	1-129-719-00	FILM 0.027MF	5% 630V
R7506	1-216-073-00	RES,CHIP 10K	5% 1/10W	C660	1-111-057-11	ELECT 120MF	20% 25V
R7507	1-216-089-91	RES,CHIP 47K	5% 1/10W	C661	1-128-526-11	ELECT 100MF	20% 16V
R7508	1-216-073-00	RES,CHIP 10K	5% 1/10W	C662	1-137-399-11	FILM 0.1MF	5% 50V
R7509	1-216-073-00	RES,CHIP 10K	5% 1/10W	C663	1-126-965-11	ELECT 22MF	20% 50V
R7510	1-216-073-00	RES,CHIP 10K	5% 1/10W	C670	1-137-370-11	FILM 0.01MF	5% 50V
R7511	1-216-073-00	RES,CHIP 10K	5% 1/10W	C671	1-107-966-51	ELECT 220MF	20% 250V
				C672 1-107-959-11 ELECT 3.3MF 20% 250V			
				C673 1-107-935-11 ELECT 330MF 20% 100V			
				C674 1-107-928-11 ELECT 4.7MF 20% 100V			
				C675 1-107-890-11 ELECT 2200MF 20% 25V			
				C676 1-107-888-11 ELECT 47MF 20% 25V			
				C677 1-107-890-11 ELECT 2200MF 20% 25V			
				C678 1-107-888-11 ELECT 47MF 20% 25V			
				C679 1-126-927-11 ELECT 2200MF 20% 10V			
				C680 1-126-927-11 ELECT 2200MF 20% 10V			
				C681 1-107-905-11 ELECT 4.7MF 20% 50V			
				C682 1-126-963-11 ELECT 4.7MF 20% 50V			
				C683 1-164-646-11 CERAMIC 2200PF 10% 500V			
				C684 1-137-370-11 FILM 0.01MF 5% 50V			
				C685 1-107-909-11 ELECT 47MF 20% 50V			
				C690 1-107-888-11 ELECT 47MF 20% 25V			



The components identified by shading and mark Δ are critical for safety. Replace only with part number specified.

Les composants identifiés par un trame et une marque Δ sont critiques pour la sécurité. Ne les remplacer que par une pièce portant le numéro spécifié.

REF.NO.	PART NO.	DESCRIPTION	REMARK	REF.NO.	PART NO.	DESCRIPTION	REMARK
C691	1-107-888-11	ELECT	47MF 20% 25V		<IC>		
C692	1-111-016-11	ELECT	0.0012F 20% 10V				
C693	1-137-399-11	FILM	0.1MF 5% 50V	IC630	8-749-013-03	IC DM-60	
C695	1-164-644-11	CERAMIC	330PF 10% 500V	IC660	8-759-470-64	IC TOP223Y-BB	
C697	1-136-165-00	FILM	0.1MF 5% 50V	IC690	8-749-011-42	IC SI-3050F	
				IC691	8-759-140-85	IC UPC1093J	
					<COIL>		
				L610	1-416-409-11	INDUCTOR	0UH
				L611	1-411-674-11	INDUCTOR	0UH
				L670	1-412-529-11	INDUCTOR	22UH
				L671	1-412-529-11	INDUCTOR	22UH
				L672	1-412-529-11	INDUCTOR	22UH
				L673	1-412-529-11	INDUCTOR	22UH
				L691	1-412-529-11	INDUCTOR	22UH
					<PHOTO COUPLER>		
				PH660	8-749-010-64	PHOTO COUPLER PC123F2	
				PH680	8-749-010-64	PHOTO COUPLER PC123F2	
					<IC LINK>		
				PS670 Δ	1-533-593-31	LINK, IC (2A/90V AC, 60V DC)	
				PS671 Δ	1-533-593-31	LINK, IC (2A/90V AC, 60V DC)	
				PS673 Δ	1-533-593-31	LINK, IC (2A/90V AC, 60V DC)	
				PS674 Δ	1-533-593-31	LINK, IC (2A/90V AC, 60V DC)	
					<TRANSISTOR>		
				Q610	8-729-041-65	TRANSISTOR 2SK2195F04	
				Q615	8-729-026-49	TRANSISTOR 2SA1037AK-T146-R	
				Q640	8-729-041-12	TRANSISTOR MX0841AB-F	
				Q641	8-729-119-76	TRANSISTOR 2SA1175-HFE	
				Q642	8-729-119-78	TRANSISTOR 2SC2785-HFE	
				Q660	8-729-119-78	TRANSISTOR 2SC2785-HFE	
				Q680	8-729-120-28	TRANSISTOR 2SC1623-L5L6	
				Q681	8-729-230-45	TRANSISTOR 2SC2458-YGR	
				Q682	8-729-119-76	TRANSISTOR 2SA1175-HFE	
				Q683	8-729-119-76	TRANSISTOR 2SA1175-HFE	
				Q690	8-729-119-78	TRANSISTOR 2SC2785-HFE	
				Q691	8-729-026-49	TRANSISTOR 2SA1037AK-T146-R	
					<RESISTOR>		
				R601 Δ	1-220-825-91	CARBON	330K 5% 1/2W
				R604	1-260-089-11	CARBON	150 5% 1/2W
				R610	1-216-383-11	METAL OXIDE	0.33 5% 3W F
				R611	1-216-383-11	METAL OXIDE	0.33 5% 3W F
				R612	1-215-477-00	METAL	220K 1% 1/4W
				R613	1-215-477-00	METAL	220K 1% 1/4W
				R614	1-215-473-00	METAL	150K 1% 1/4W
				R615	1-215-473-00	METAL	150K 1% 1/4W
				R616	1-215-473-00	METAL	150K 1% 1/4W
				R617	1-215-481-00	METAL	330K 1% 1/4W
					<CONNECTOR>		
				CN603*1	580-689-11	PIN, CONNECTOR (PC BOARD) 4P	
				CN604	1-691-960-11	PIN, CONNECTOR (PC BOARD) 3P	
				CN605	1-691-960-11	PIN, CONNECTOR (PC BOARD) 3P	
				CN610*1	1-774-511-11	CONNECTOR, BOARD TO BOARD 10P	
				CN671*1	1-564-514-11	PLUG, CONNECTOR 11P	
				CN672*1	1-564-512-11	PLUG, CONNECTOR 9P	
				CN673*1	1-564-508-11	PLUG, CONNECTOR 5P	
					<DIODE>		
				D610 Δ	8-719-510-53	DIODE D4SB60L	
				D611	8-719-029-04	DIODE D5L60	
				D612	8-719-304-63	DIODE RM11C	
				D613	8-719-110-49	ZENER DIODE RD18ESB2	
				D614	8-719-977-28	ZENER DIODE DTZ10B	
				D617	8-719-404-49	DIODE MA111	
				D640	8-719-404-49	DIODE MA111	
				D660	8-719-059-23	DIODE P6KE200AG23	
				D661	8-719-979-64	DIODE UF4005PKG23	
				D662	8-719-058-91	DIODE AG01A-V0	
				D663	8-719-110-31	ZENER DIODE RD12ESB2	
				D666	8-719-105-99	ZENER DIODE RD6.2M-B1	
				D670	8-719-064-49	DIODE D4SBL40	
				D671	8-719-510-64	DIODE S2LA20F	
				D672	8-719-052-91	DIODE D4SBS4-F	
				D673	8-719-022-97	DIODE D2S4MF	
				D674	8-719-022-97	DIODE D2S4MF	
				D677	8-719-911-19	DIODE 1SS119-25	
				D678	8-719-911-19	DIODE 1SS119-25	
				D680	8-719-404-49	DIODE MA111	
				D681	8-719-404-49	DIODE MA111	
				D682	8-719-510-64	DIODE S2LA20F	
				D683	8-719-911-19	DIODE 1SS119-25	
				D684	8-719-110-57	ZENER DIODE RD22ESB2	
				D691	8-719-510-37	DIODE D5LC20U	
				D692	8-719-911-19	DIODE 1SS119-25	
				D693	8-719-404-49	DIODE MA111	
					<FUSE>		
				F601 Δ	1-576-233-11	FUSE (H.B.C.) (6.3A/250V)	
					1-533-223-11	HOLDER, FUSE ; F601	
					<FERRITE BEAD>		
				FB610	1-410-396-41	FERRITE	0.45UH
				FB611	1-410-396-41	FERRITE	0.45UH
				FB612	1-410-396-41	FERRITE	0.45UH

GDM-5010PT



Les composants identifiés par un tramé et une marque Δ sont critiques pour la sécurité. Ne les remplacer que par une pièce portant le numéro spécifié.

The components identified by shading and mark Δ are critical for safety. Replace only with part number specified.

REF.NO.	PART NO.	DESCRIPTION	REMARK	REF.NO.	PART NO.	DESCRIPTION	REMARK
R618	1-215-477-00	METAL	220K 1% 1/4W	R692	1-260-085-11	CARBON	68 5% 1/2W
R619	1-215-485-00	METAL	470K 1% 1/4W	R693	1-216-065-00	RES,CHIP	4.7K 5% 1/10W
R620	1-215-485-00	METAL	470K 1% 1/4W	R694	1-216-073-00	RES,CHIP	10K 5% 1/10W
R621	1-215-481-00	METAL	330K 1% 1/4W	R695	1-249-443-11	CARBON	0.47 5% 1/4W F
R622	1-216-049-91	RES,CHIP	1K 5% 1/10W	R696	1-216-633-11	METAL CHIP	180 0.50%1/10W
R623	1-216-651-11	METAL CHIP	1K 0.50%1/10W	R697	1-216-649-11	METAL CHIP	820 0.50%1/10W
R624	1-216-671-11	METAL CHIP	6.8K 0.50%1/10W	R698	1-216-073-00	RES,CHIP	10K 5% 1/10W
R625	1-249-389-11	CARBON	4.7 5% 1/4W	R699	1-216-081-00	RES,CHIP	22K 5% 1/10W
R626	1-249-429-11	CARBON	10K 5% 1/4W				
R627	1-215-479-00	METAL	270K 1% 1/4W				
R628	1-215-481-00	METAL	330K 1% 1/4W	<RELAY>			
R629	1-215-461-00	METAL	47K 1% 1/4W	RY601 Δ 1-515-669-21 RELAY			
R631	1-247-807-31	CARBON	100 5% 1/4W	RY602 Δ 1-755-031-11 RELAY			
R632	1-216-073-00	RES,CHIP	10K 5% 1/10W				
R633	1-215-481-00	METAL	330K 1% 1/4W				
R635	1-216-073-00	RES,CHIP	10K 5% 1/10W	<TRANSFORMER>			
R640	1-202-933-61	FUSIBLE	0.1 10% 1/2W F	T601 Δ 1-429-180-11 TRANSFORMER, LINE FILTER			
R641	1-218-642-11	METAL OXIDE	100K 5% 1W F	T640 1-431-538-11 TRANSFORMER, CONVERTER (PIT)			
R642	1-218-642-11	METAL OXIDE	100K 5% 1W F	T641 1-429-992-11 TRANSFORMER, CONVERTER (PRT)			
R643	1-247-863-91	CARBON	22K 5% 1/4W	T660 1-431-565-11 TRANSFORMER, CONVERTER (SRT)			
R644	1-216-105-91	RES,CHIP	220K 5% 1/10W				
R645	1-216-081-00	RES,CHIP	22K 5% 1/10W	<THERMISTOR>			
R646	1-216-073-00	RES,CHIP	10K 5% 1/10W				
R647	1-249-441-11	CARBON	100K 5% 1/4W	TH601 Δ 1-809-260-11 THERMISTOR, POWER			
R648	1-216-353-00	METAL OXIDE	2.2 5% 1W F	THP601 Δ 1-809-827-11 THERMISTOR, POSITIVE			
R649	1-218-642-11	METAL OXIDE	100K 5% 1W F				
R650	1-218-642-11	METAL OXIDE	100K 5% 1W F	<VARISTOR>			
R651	1-216-353-00	METAL OXIDE	2.2 5% 1W F				
R652	1-212-942-00	FUSIBLE	2.2 5% 1/2W F	VDR601 Δ 1-801-268-51 VARISTOR TNR14V471K660			
R655	1-216-073-00	RES,CHIP	10K 5% 1/10W	VDR602 Δ 1-810-622-21 VARISTOR			
R661	1-249-387-11	CARBON	3.3 5% 1/4W F	VDR640 1-810-974-21 VARISTOR TNR10V431K660			
R662	1-216-073-00	RES,CHIP	10K 5% 1/10W				
R663	1-216-073-00	RES,CHIP	10K 5% 1/10W	*****			
R664	1-247-791-91	CARBON	22 5% 1/4W	* 8-933-311-00 D BOARD, COMPLETE			
R665	1-216-033-00	RES,CHIP	220 5% 1/10W	*****			
R666	1-215-441-00	METAL	6.8K 1% 1/4W				
R667	1-215-433-00	METAL	3.3K 1% 1/4W				
R668	1-249-401-11	CARBON	47 5% 1/4W	4-040-989-01 SPRING (A), TR RETAINER (IC702, R511)			
R669	1-216-057-00	RES,CHIP	2.2K 5% 1/10W	4-040-992-01 SPRING (AA), TR RETAINER (IC502, Q507)			
R671	1-216-113-00	RES,CHIP	470K 5% 1/10W	4-040-994-01 SPRING (BB), TR RETAINER (Q508, D519)			
R672	1-216-049-91	RES,CHIP	1K 5% 1/10W	4-047-285-01 SHEET, INSULATING (Q909)			
R673	1-249-413-11	CARBON	470 5% 1/4W F	4-060-720-01 SHEET, INSULATE (Q508)			
R674	1-249-377-11	CARBON	0.47 5% 1/4W F				
R675	1-260-292-11	CARBON	1 5% 1/2W				
R676	1-249-413-11	CARBON	470 5% 1/4W	4-060-844-01 SHEET, INSULATING (IC702)			
R680	1-216-073-00	RES,CHIP	10K 5% 1/10W	4-382-854-01 SCREW (M3X8), P, SW (+) (R937)			
R681	1-216-049-91	RES,CHIP	1K 5% 1/10W	4-382-854-11 SCREW (M3X10), P, SW (+) (IC702, Q704, Q706, Q908, Q909, R937)			
R682	1-216-065-00	RES,CHIP	4.7K 5% 1/10W	7-685-647-79 SCREW +BVTP 3X10 TYPE2 IT-3 (IC502, Q507, Q508, D519, R511)			
R683	1-216-025-91	RES,CHIP	100 5% 1/10W				
R685	1-216-073-00	RES,CHIP	10K 5% 1/10W	<CAPACITOR>			
R686	1-216-049-91	RES,CHIP	1K 5% 1/10W				
R687	1-216-049-91	RES,CHIP	1K 5% 1/10W				
R688	1-216-073-00	RES,CHIP	10K 5% 1/10W	C001	1-164-232-11	CERAMIC CHIP 0.01MF	10% 50V
R689	1-216-073-00	RES,CHIP	10K 5% 1/10W	C002	1-163-009-11	CERAMIC CHIP 0.001MF	10% 50V
R691	1-216-073-00	RES,CHIP	10K 5% 1/10W	C003	1-163-019-00	CERAMIC CHIP 0.0068MF	10% 50V
				C004	1-164-232-11	CERAMIC CHIP 0.01MF	10% 50V



REF.NO.	PART NO.	DESCRIPTION	REMARK	REF.NO.	PART NO.	DESCRIPTION	REMARK
C005	1-164-232-11	CERAMIC CHIP 0.01MF	10% 50V	C063	1-137-399-11	FILM 0.1MF	5% 50V
C006	1-126-960-11	ELECT 1MF	20% 50V	C065	1-126-965-11	ELECT 22MF	20% 50V
C007	1-164-232-11	CERAMIC CHIP 0.01MF	10% 50V	C066	1-164-232-11	CERAMIC CHIP 0.01MF	10% 50V
C008	1-164-004-11	CERAMIC CHIP 0.1MF	10% 25V	C067	1-163-243-11	CERAMIC CHIP 47PF	5% 50V
C009	1-164-004-11	CERAMIC CHIP 0.1MF	10% 25V	C068	1-126-964-11	ELECT 10MF	20% 50V
C010	1-163-237-11	CERAMIC CHIP 27PF	5% 50V	C069	1-164-232-11	CERAMIC CHIP 0.01MF	10% 50V
C011	1-163-237-11	CERAMIC CHIP 27PF	5% 50V	C070	1-164-232-11	CERAMIC CHIP 0.01MF	10% 50V
C012	1-164-004-11	CERAMIC CHIP 0.1MF	10% 25V	C072	1-126-960-11	ELECT 1MF	20% 50V
C013	1-126-967-11	ELECT 47MF	20% 50V	C074	1-163-009-11	CERAMIC CHIP 0.001MF	10% 50V
C014	1-107-914-11	ELECT 1000MF	20% 25V	C075	1-164-232-11	CERAMIC CHIP 0.01MF	10% 50V
C015	1-107-914-11	ELECT 1000MF	20% 25V	C076	1-163-809-11	CERAMIC CHIP 0.047MF	10% 25V
C016	1-163-009-11	CERAMIC CHIP 0.001MF	10% 50V	C077	1-164-004-11	CERAMIC CHIP 0.1MF	10% 25V
C017	1-164-004-11	CERAMIC CHIP 0.1MF	10% 25V	C078	1-164-004-11	CERAMIC CHIP 0.1MF	10% 25V
C018	1-164-004-11	CERAMIC CHIP 0.1MF	10% 25V	C079	1-126-967-11	ELECT 47MF	20% 50V
C019	1-126-967-11	ELECT 47MF	20% 50V	C080	1-126-967-11	ELECT 47MF	20% 50V
C020	1-164-232-11	CERAMIC CHIP 0.01MF	10% 50V	C081	1-164-232-11	CERAMIC CHIP 0.01MF	10% 50V
C021	1-163-023-00	CERAMIC CHIP 0.015MF	10% 50V	C082	1-126-964-11	ELECT 10MF	20% 50V
C022	1-126-933-11	ELECT 100MF	20% 16V	C083	1-137-399-11	FILM 0.1MF	5% 50V
C023	1-163-009-11	CERAMIC CHIP 0.001MF	10% 50V	C084	1-164-004-11	CERAMIC CHIP 0.1MF	10% 25V
C024	1-164-232-11	CERAMIC CHIP 0.01MF	10% 50V	C085	1-137-399-11	FILM 0.1MF	5% 50V
C025	1-126-960-11	ELECT 1MF	20% 50V	C086	1-126-964-11	ELECT 10MF	20% 50V
C026	1-137-372-11	FILM 0.022MF	5% 50V	C087	1-164-004-11	CERAMIC CHIP 0.1MF	10% 25V
C027	1-164-004-11	CERAMIC CHIP 0.1MF	10% 25V	C090	1-109-982-11	CERAMIC CHIP 1MF	10% 10V
C028	1-164-695-11	CERAMIC CHIP 0.0022MF	5% 50V	C092	1-164-232-11	CERAMIC CHIP 0.01MF	10% 50V
C029	1-126-960-11	ELECT 1MF	20% 50V	C093	1-126-964-11	ELECT 10MF	20% 50V
C030	1-164-004-11	CERAMIC CHIP 0.1MF	10% 25V	C094	1-164-232-11	CERAMIC CHIP 0.01MF	10% 50V
C031	1-164-232-11	CERAMIC CHIP 0.01MF	10% 50V	C095	1-164-232-11	CERAMIC CHIP 0.01MF	10% 50V
C032	1-163-019-00	CERAMIC CHIP 0.0068MF	10% 50V	C096	1-164-232-11	CERAMIC CHIP 0.01MF	10% 50V
C034	1-164-232-11	CERAMIC CHIP 0.01MF	10% 50V	C097	1-164-232-11	CERAMIC CHIP 0.01MF	10% 50V
C035	1-163-253-11	CERAMIC CHIP 120PF	5% 50V	C098	1-164-232-11	CERAMIC CHIP 0.01MF	10% 50V
C036	1-164-004-11	CERAMIC CHIP 0.1MF	10% 25V	C099	1-164-004-11	CERAMIC CHIP 0.1MF	10% 25V
C037	1-126-934-11	ELECT 220MF	20% 16V	C501	1-107-909-11	ELECT 47MF	20% 50V
C038	1-164-004-11	CERAMIC CHIP 0.1MF	10% 25V	C502	1-163-259-91	CERAMIC CHIP 220PF	5% 50V
C039	1-126-964-11	ELECT 10MF	20% 50V	C503	1-136-169-00	FILM 0.22MF	5% 50V
C040	1-126-963-11	ELECT 4.7MF	20% 50V	C504	1-137-605-11	FILM 0.01MF	10% 250V
C041	1-126-960-11	ELECT 1MF	20% 50V	C505	1-163-251-11	CERAMIC CHIP 100PF	5% 50V
C042	1-126-967-11	ELECT 47MF	20% 50V	C506	1-136-169-00	FILM 0.22MF	5% 50V
C043	1-126-967-11	ELECT 47MF	20% 50V	C507	1-136-173-00	FILM 0.47MF	5% 50V
C044	1-126-967-11	ELECT 47MF	20% 50V	C508	1-163-037-11	CERAMIC CHIP 0.022MF	10% 50V
C045	1-163-137-00	CERAMIC CHIP 680PF	5% 50V	C509	1-126-941-11	ELECT 470MF	20% 25V
C046	1-164-004-11	CERAMIC CHIP 0.1MF	10% 25V	C510	1-137-368-11	FILM 0.0047MF	5% 50V
C047	1-126-934-11	ELECT 220MF	20% 16V	C511	1-117-398-11	ELECT 33MF	20% 250V
C048	1-164-695-11	CERAMIC CHIP 0.0022MF	5% 50V	C512	1-107-889-11	ELECT 220MF	20% 25V
C049	1-163-137-00	CERAMIC CHIP 680PF	5% 50V	C513	1-163-017-00	CERAMIC CHIP 0.0047MF	10% 50V
C050	1-163-809-11	CERAMIC CHIP 0.047MF	10% 25V	C514	1-164-232-11	CERAMIC CHIP 0.01MF	10% 50V
C051	1-126-960-11	ELECT 1MF	20% 50V	C515	1-107-889-11	ELECT 220MF	20% 25V
C052	1-163-809-11	CERAMIC CHIP 0.047MF	10% 25V	C516	1-137-399-11	FILM 0.1MF	5% 50V
C054	1-126-963-11	ELECT 4.7MF	20% 50V	C517	1-104-574-11	CERAMIC 0.0047MF	10% 2KV
C055	1-126-963-11	ELECT 4.7MF	20% 50V	C518	1-117-959-11	FILM 4700PF	3% 1.8KV
C056	1-163-809-11	CERAMIC CHIP 0.047MF	10% 25V	C519	1-107-444-11	CERAMIC 100PF	5% 2KV
C057	1-107-909-11	ELECT 47MF	20% 50V	C520	1-136-553-11	FILM 0.0015MF	5% 630V
C058	1-126-934-11	ELECT 220MF	20% 16V	C521	1-107-597-11	CERAMIC 22PF	5% 500V
C059	1-164-232-11	CERAMIC CHIP 0.01MF	10% 50V	C522	1-107-444-11	CERAMIC 100PF	5% 2KV
C060	1-126-964-11	ELECT 10MF	20% 50V	C523	1-137-370-11	FILM 0.01MF	5% 50V
C061	1-164-232-11	CERAMIC CHIP 0.01MF	10% 50V	C524	1-113-694-11	FILM 0.056MF	5% 250V

GDM-5010PT



REF.NO.	PART NO.	DESCRIPTION	REMARK	REF.NO.	PART NO.	DESCRIPTION	REMARK
C525	1-107-846-11	FILM	0.1MF 5% 250V	C901	1-107-889-11	ELECT	220MF 20% 25V
C526	1-115-514-11	FILM	0.22MF 5% 250V	C902	1-163-809-11	CERAMIC CHIP	0.047MF 10% 25V
C527	1-115-517-11	FILM	0.39MF 5% 250V	C903	1-163-259-91	CERAMIC CHIP	220PF 5% 50V
C528	1-115-521-11	FILM	0.82MF 5% 250V	C904	1-137-605-11	FILM	0.01MF 10% 250V
C529	1-107-683-11	ELECT	2.2MF 0 250V	C905	1-104-653-11	ELECT	220MF 20% 16V
C530	1-164-232-11	CERAMIC CHIP	0.01MF 10% 50V	C906	1-106-220-00	MYLAR	0.1MF 10% 100V
C531	1-164-232-11	CERAMIC CHIP	0.01MF 10% 50V	C907	1-119-748-11	ELECT	33MF 20% 400V
C532	1-164-232-11	CERAMIC CHIP	0.01MF 10% 50V	C908	1-136-169-00	FILM	0.22MF 5% 50V
C533	1-164-232-11	CERAMIC CHIP	0.01MF 10% 50V	C909	1-106-355-12	MYLAR	0.0033MF 10% 200V
C534	1-164-232-11	CERAMIC CHIP	0.01MF 10% 50V	C910	1-164-232-11	CERAMIC CHIP	0.01MF 10% 50V
C535	1-164-232-11	CERAMIC CHIP	0.01MF 10% 50V	C911	1-163-275-11	CERAMIC CHIP	0.001MF 5% 50V
C536	1-128-526-11	ELECT	100MF 20% 25V	C912	1-163-275-11	CERAMIC CHIP	0.001MF 5% 50V
C537	1-115-523-21	FILM	1.2MF 5% 250V	C913	1-164-004-11	CERAMIC CHIP	0.1MF 10% 25V
C538	1-117-958-11	FILM	0.24MF 5% 400V	C914	1-163-275-11	CERAMIC CHIP	0.001MF 5% 50V
C539	1-107-960-11	ELECT	4.7MF 20% 250V	C915	1-164-232-11	CERAMIC CHIP	0.01MF 10% 50V
C540	1-106-343-00	MYLAR	0.001MF 10% 200V	C916	1-136-064-00	FILM	2200PF 3% 1.2KV
C541	1-163-243-11	CERAMIC CHIP	47PF 5% 50V	C917	1-107-889-11	ELECT	220MF 20% 25V
C542	1-163-243-11	CERAMIC CHIP	47PF 5% 50V	C919	1-164-232-11	CERAMIC CHIP	0.01MF 10% 50V
C544	1-137-368-11	FILM	0.0047MF 5% 50V	C920	1-163-009-11	CERAMIC CHIP	0.001MF 10% 50V
C545	1-126-967-11	ELECT	47MF 20% 50V	C921	1-163-243-11	CERAMIC CHIP	47PF 5% 50V
C547	1-126-967-11	ELECT	47MF 20% 50V	C922	1-117-665-11	FILM	0.33MF 5% 200V
C549	1-164-232-11	CERAMIC CHIP	0.01MF 10% 50V	C923	1-106-359-00	MYLAR	0.0047MF 10% 100V
C550	1-164-232-11	CERAMIC CHIP	0.01MF 10% 50V	C924	1-106-220-00	MYLAR	0.1MF 10% 100V
C551	1-163-009-11	CERAMIC CHIP	0.001MF 10% 50V	C925	1-137-372-11	FILM	0.022MF 5% 50V
C553	1-126-963-11	ELECT	4.7MF 20% 50V	C926	1-106-228-00	MYLAR	0.22MF 10% 100V
C554	1-163-037-11	CERAMIC CHIP	0.022MF 10% 50V	C927	1-107-903-11	ELECT	2.2MF 20% 50V
C555	1-163-037-11	CERAMIC CHIP	0.022MF 10% 50V	C928	1-164-232-11	CERAMIC CHIP	0.01MF 10% 50V
C556	1-163-009-11	CERAMIC CHIP	0.001MF 10% 50V	C929	1-128-526-11	ELECT	100MF 20% 25V
C557	1-115-185-11	CERAMIC CHIP	0.033MF 10% 50V	C930	1-164-232-11	CERAMIC CHIP	0.01MF 10% 50V
C559	1-162-134-11	CERAMIC	470PF 10% 2KV	C931	1-164-232-11	CERAMIC CHIP	0.01MF 10% 50V
C561	1-136-173-00	FILM	0.47MF 5% 50V	C945	1-107-909-11	ELECT	47MF 20% 50V
C562	1-164-232-11	CERAMIC CHIP	0.01MF 10% 50V	C1003	1-164-232-11	CERAMIC CHIP	0.01MF 10% 50V
C563	1-117-214-11	CERAMIC	0.001MF 10% 2KV	C1004	1-164-232-11	CERAMIC CHIP	0.01MF 10% 50V
C564	1-126-963-11	ELECT	4.7MF 20% 50V	C1005	1-164-232-11	CERAMIC CHIP	0.01MF 10% 50V
C666	1-164-232-11	CERAMIC CHIP	0.01MF 10% 50V	C1006	1-164-232-11	CERAMIC CHIP	0.01MF 10% 50V
C667	1-126-967-11	ELECT	47MF 20% 50V	C1007	1-164-232-11	CERAMIC CHIP	0.01MF 10% 50V
C701	1-126-967-11	ELECT	47MF 20% 50V	C1008	1-164-232-11	CERAMIC CHIP	0.01MF 10% 50V
C702	1-137-399-11	FILM	0.1MF 5% 50V	C1009	1-126-960-11	ELECT	1MF 20% 50V
C705	1-126-942-61	ELECT	1000MF 20% 25V	C1501	1-164-232-11	CERAMIC CHIP	0.01MF 10% 50V
C706	1-164-232-11	CERAMIC CHIP	0.01MF 10% 50V	C1502	1-117-722-11	ELECT	2200MF 20% 10V
C707	1-164-232-11	CERAMIC CHIP	0.01MF 10% 50V	C1503	1-163-001-11	CERAMIC CHIP	220PF 10% 50V
C709	1-137-399-11	FILM	0.1MF 5% 50V				
C710	1-163-019-00	CERAMIC CHIP	0.0068MF 10% 50V			<CONNECTOR>	
C711	1-107-894-11	ELECT	220MF 20% 35V	CN501*	1-564-512-11	PLUG, CONNECTOR	9P
C712	1-106-228-00	MYLAR	0.22MF 10% 100V	CN502*	1-564-514-11	PLUG, CONNECTOR	11P
C713	1-126-942-61	ELECT	1000MF 20% 25V	CN503*	1-564-510-11	PLUG, CONNECTOR	7P
C714	1-126-967-11	ELECT	47MF 20% 50V	CN504*	1-564-508-11	PLUG, CONNECTOR	5P
C715	1-107-932-11	ELECT	47MF 20% 100V	CN505*	1-508-879-11	BASE POST	
C717	1-107-930-91	ELECT	22MF 20% 100V				
C729	1-162-134-11	CERAMIC	470PF 10% 2KV	CN506*	1-564-511-11	PLUG, CONNECTOR	8P
C735	1-137-399-11	FILM	0.1MF 5% 50V	CN507	1-764-101-11	PIN, CONNECTOR (PC BOARD)	2P
C746	1-163-009-11	CERAMIC CHIP	0.001MF 10% 50V	CN508*	1-778-955-11	PIN, CONNECTOR (PC BOARD)	10P
C747	1-164-232-11	CERAMIC CHIP	0.01MF 10% 50V	CN509	1-564-505-11	PLUG, CONNECTOR	2P
C750	1-126-964-11	ELECT	10MF 20% 50V	CN511*	1-564-514-11	PLUG, CONNECTOR	11P
C751	1-164-232-11	CERAMIC CHIP	0.01MF 10% 50V	CN512*	1-564-512-11	PLUG, CONNECTOR	9P



REF.NO.	PART NO.	DESCRIPTION	REMARK	REF.NO.	PART NO.	DESCRIPTION	REMARK
CN520*	1-564-509-11	PLUG, CONNECTOR 6P		D715	8-719-911-19	DIODE 1SS119-25	
CN901*	1-564-520-11	PLUG, CONNECTOR 5P		D718	8-719-976-99	ZENER DIODE DTZ5.1B	
		<DIODE>		D720	8-719-028-72	DIODE RGP02-17EL-6433	
D004	8-719-800-76	DIODE 1SS226		D721	8-719-028-72	DIODE RGP02-17EL-6433	
D007	8-719-976-99	ZENER DIODE DTZ5.1B		D901	8-719-404-49	DIODE MA111	
D008	8-719-976-99	ZENER DIODE DTZ5.1B		D902	8-719-404-49	DIODE MA111	
D009	8-719-976-99	ZENER DIODE DTZ5.1B		D903	8-719-911-19	DIODE 1SS119-25	
D010	8-719-976-99	ZENER DIODE DTZ5.1B		D904	8-719-404-49	DIODE MA111	
D012	8-719-800-76	DIODE 1SS226		D905	8-719-404-49	DIODE MA111	
D013	8-719-800-76	DIODE 1SS226		D906	8-719-404-49	DIODE MA111	
D014	8-719-800-76	DIODE 1SS226		D907	8-719-158-49	ZENER DIODE RD12SB2	
D015	8-719-800-76	DIODE 1SS226		D908	8-719-158-49	ZENER DIODE RD12SB2	
D016	8-719-800-76	DIODE 1SS226		D909	8-719-977-40	ZENER DIODE DTZ13B	
D019	8-719-800-76	DIODE 1SS226		D910	8-719-063-89	DIODE YG911S3R	
D020	8-719-800-76	DIODE 1SS226		D911	8-719-978-69	ZENER DIODE DTZ-TT11-16B	
D025	8-719-976-99	ZENER DIODE DTZ5.1B		D913	8-719-158-49	ZENER DIODE RD12SB2	
D026	8-719-800-76	DIODE 1SS226		D915	8-719-109-85	ZENER DIODE RD5.1ESB2	
D027	8-719-800-76	DIODE 1SS226		D916	8-719-939-79	DIODE GMA01-BT	
D028	8-719-800-76	DIODE 1SS226		D917	8-719-110-46	DIODE RD16ESB3	
D029	8-719-800-76	DIODE 1SS226		D919	8-719-911-19	DIODE 1SS119-25	
D032	8-719-976-99	ZENER DIODE DTZ5.1B		D921	8-719-404-49	DIODE MA111	
D033	8-719-976-99	ZENER DIODE DTZ5.1B		D922	8-719-404-49	DIODE MA111	
D034	8-719-801-78	DIODE 1SS184		D923	8-719-404-49	DIODE MA111	
D035	8-719-801-78	DIODE 1SS184		D924	8-719-976-99	ZENER DIODE DTZ5.1B	
D050	8-719-404-49	DIODE MA111		D935	8-719-977-81	ZENER DIODE DTZ33B	
D501	8-719-977-40	ZENER DIODE DTZ13B		D1501	8-719-976-99	ZENER DIODE DTZ5.1B	
D502	8-719-063-89	DIODE YG911S3R		D1502	8-719-404-49	DIODE MA111	
D503	8-719-404-49	DIODE MA111		D1503	8-719-404-49	DIODE MA111	
D504	8-719-984-73	DIODE SB560				<FERRITE BEAD>	
D505	8-719-018-82	DIODE RGP02-20EL-6394		FB501	1-410-397-21	FERRITE 1.1UH	
D506	8-719-911-19	DIODE 1SS119-25		FB502	1-410-397-21	FERRITE 1.1UH	
D507	8-719-911-19	DIODE 1SS119-25		FB901	1-410-397-21	FERRITE 1.1UH	
D508	8-719-109-85	DIODE RD5.1ESB2		FB1025	1-414-232-11	INDUCTOR CHIP	OUH
D509	8-719-911-19	DIODE 1SS119-25		FB1026	1-414-232-11	INDUCTOR CHI	OUH
D510	8-719-951-30	DIODE ERA91-02				<IC>	
D511	8-719-911-19	DIODE 1SS119-25		IC001	8-759-499-98	IC MB90553PF-G-112-BND	
D512	8-719-018-82	DIODE RGP02-20EL-6394		IC002	8-759-442-20	IC 24LC21A/SN	
D513	8-719-404-49	DIODE MA111		IC003	8-759-168-20	IC TA78L09S	
D514	8-719-109-93	ZENER DIODE RD6.2ESB2		IC004	8-759-454-79	IC 24LC16BT/SN	
D516	8-719-105-99	ZENER DIODE RD6.2M-B1		IC005	8-759-162-80	IC MM1170BFB	
D517	8-719-105-99	ZENER DIODE RD6.2M-B1		IC006	8-759-231-53	IC TA7805S	
D518	8-719-404-49	DIODE MA111		IC007	8-752-078-46	IC CXA2043Q	
D519	8-719-066-36	DIODE FMQ-G5GS		IC008	8-759-701-59	IC NJM78M09FA	
D520	8-719-031-34	DIODE RGP02-20EG23		IC009	8-759-082-57	IC TC7W04FU	
D521	8-719-404-49	DIODE MA111		IC010	8-752-083-83	IC CXA2044M-T6	
D660	8-719-977-69	ZENER DIODE DTZ24B		IC011	8-759-708-05	IC NJM78L05A	
D701	8-719-158-15	ZENER DIODE RD5.6SB		IC012	8-759-442-20	IC 24LC21A/SN	
D704	8-719-404-49	DIODE MA111		IC013	8-759-233-66	IC TC74HCT04AF	
D705	8-719-404-49	DIODE MA111		IC502	8-759-803-42	IC LA6500-FA	
D706	8-719-976-99	ZENER DIODE DTZ5.1B		IC505	8-759-100-96	IC UPC4558G2	
D709	8-719-979-85	DIODE EGP20G		IC701	8-759-822-38	IC LA6510	
D713	8-719-911-19	DIODE 1SS119-25					
D714	8-719-911-19	DIODE 1SS119-25					



Les composants identifiés par un tramé et une marque Δ sont critiques pour la sécurité. Ne les remplacer que par une pièce portant le numéro spécifié.

The components identified by shading and mark Δ are critical for safety. Replace only with part number specified.

REF.NO.	PART NO.	DESCRIPTION	REMARK	REF.NO.	PART NO.	DESCRIPTION	REMARK
IC702	8-759-444-82	IC LA7841L		Q508	8-729-031-87	TRANSISTOR 2SC5047-CA	
IC703	8-759-100-96	IC UPC4558G2		Q509	8-729-033-25	TRANSISTOR DTC114GKA	
IC901	8-759-467-70	IC BA9756FS-E2					
<CHIP CONDUCTOR>							
JR001	1-216-295-91	SHORT	0	Q510	8-729-120-28	TRANSISTOR 2SC1623-L5L6	
JR002	1-216-295-91	SHORT	0	Q511	8-729-140-50	TRANSISTOR 2SC3209LK	
JR003	1-216-295-91	SHORT	0	Q512	8-729-120-28	TRANSISTOR 2SC1623-L5L6	
JR004	1-216-295-91	SHORT	0	Q517	8-729-216-22	TRANSISTOR 2SA1162-G	
				Q522	8-729-043-41	TRANSISTOR 2SK2098-01MR-F119	
<COIL>							
L001	1-406-665-11	INDUCTOR	0UH	Q523	8-729-043-41	TRANSISTOR 2SK2098-01MR-F119	
L002	1-406-665-11	INDUCTOR	0UH	Q524	8-729-043-41	TRANSISTOR 2SK2098-01MR-F119	
L003	1-412-537-31	INDUCTOR	100UH	Q525	8-729-043-41	TRANSISTOR 2SK2098-01MR-F119	
L004	1-412-537-31	INDUCTOR	100UH	Q526	8-729-043-41	TRANSISTOR 2SK2098-01MR-F119	
L006	1-410-482-31	INDUCTOR	100UH	Q527	8-729-043-41	TRANSISTOR 2SK2098-01MR-F119	
L007	1-412-537-31	INDUCTOR	100UH	Q528	8-729-043-41	TRANSISTOR 2SK2098-01MR-F119	
L008	1-412-537-31	INDUCTOR	100UH	Q660	8-729-033-26	TRANSISTOR DTA114GKAT146	
L501	1-412-537-31	INDUCTOR	100UH	Q661	8-729-033-25	TRANSISTOR DTC114GKA	
L502	1-406-671-11	INDUCTOR	0UH	Q701	8-729-800-32	TRANSISTOR 2SC2362K-G	
L503	1-416-455-11	COIL, HORIZONTAL LINEARITY		Q703	8-729-178-43	TRANSISTOR 2SC2784-E	
L504	1-416-456-11	COIL, HORIZONTAL LINEARITY		Q704	8-729-207-82	TRANSISTOR 2SC3421-Y	
L505	1-406-675-11	INDUCTOR	0UH	Q705	8-729-204-91	TRANSISTOR 2SA1049-GR	
L507	1-406-675-11	INDUCTOR	0UH	Q706	8-729-207-89	TRANSISTOR 2SA1358-Y	
L701	1-412-537-31	INDUCTOR	100UH	Q707	8-729-216-22	TRANSISTOR 2SA1162-G	
L702	1-412-522-31	INDUCTOR	5.6UH	Q708	8-729-020-07	TRANSISTOR 2SC4686A(LBSONY)	
L901	1-412-537-31	INDUCTOR	100UH	Q901	8-729-120-28	TRANSISTOR 2SC1623-L5L6	
L902	1-406-660-41	INDUCTOR	0UH	Q902	8-729-216-22	TRANSISTOR 2SA1162-G	
L903	1-412-537-31	INDUCTOR	100UH	Q904	8-729-901-87	TRANSISTOR 2SC2411K-CQ	
				Q905	8-729-901-97	TRANSISTOR 2SA1036K-Q	
				Q908	8-729-035-54	TRANSISTOR 2SJ449	
				Q909	8-729-033-91	TRANSISTOR 2SK1120LBSONY2	
				Q911	8-729-033-25	TRANSISTOR DTC114GKA	
<IC LINK>				<RESISTOR>			
PS501 Δ	1-533-592-31	LINK, IC (1.6A/90V AC, 60V DC)		R001	1-216-025-91	RES,CHIP	100 5% 1/10W
PS502 Δ	1-532-984-91	LINK, IC (2A/90V)		R002	1-216-049-91	RES,CHIP	1K 5% 1/10W
PS503 Δ	1-532-984-91	LINK, IC (2A/90V)		R003	1-216-049-91	RES,CHIP	1K 5% 1/10W
PS504 Δ	1-532-984-91	LINK, IC (2A/90V)		R004	1-216-049-91	RES,CHIP	1K 5% 1/10W
PS701 Δ	1-533-590-31	LINK, IC (1A/90V AC, 60V DC)		R005	1-216-073-00	RES,CHIP	10K 5% 1/10W
PS901 Δ	1-533-592-31	LINK, IC (1.6A/90V AC, 60V DC)		R006	1-216-049-91	RES,CHIP	1K 5% 1/10W
				R007	1-216-025-91	RES,CHIP	100 5% 1/10W
				R008	1-216-089-91	RES,CHIP	47K 5% 1/10W
				R009	1-216-025-91	RES,CHIP	100 5% 1/10W
				R010	1-216-081-00	RES,CHIP	22K 5% 1/10W
<TRANSISTOR>							
Q001	8-729-027-31	TRANSISTOR DTA124EKA-T146		R011	1-216-097-91	RES,CHIP	100K 5% 1/10W
Q003	8-729-216-22	TRANSISTOR 2SA1162-G		R012	1-216-025-91	RES,CHIP	100 5% 1/10W
Q004	8-729-216-22	TRANSISTOR 2SA1162-G		R013	1-216-675-11	METAL CHIP	10K 0.50% 1/10W
Q005	8-729-216-22	TRANSISTOR 2SA1162-G		R017	1-216-049-91	RES,CHIP	1K 5% 1/10W
Q006	8-729-120-28	TRANSISTOR 2SC1623-L5L6		R018	1-216-049-91	RES,CHIP	1K 5% 1/10W
Q007	8-729-120-28	TRANSISTOR 2SC1623-L5L6		R020	1-216-049-91	RES,CHIP	1K 5% 1/10W
Q501	8-729-120-28	TRANSISTOR 2SC1623-L5L6		R023	1-216-025-91	RES,CHIP	100 5% 1/10W
Q502	8-729-120-28	TRANSISTOR 2SC1623-L5L6		R024	1-216-089-91	RES,CHIP	47K 5% 1/10W
Q503	8-729-901-97	TRANSISTOR 2SA1036K-Q		R025	1-216-295-91	SHORT	0
Q504	8-729-120-28	TRANSISTOR 2SC1623-L5L6		R026	1-216-073-00	RES,CHIP	10K 5% 1/10W
Q505	8-729-901-97	TRANSISTOR 2SA1036K-Q		R027	1-216-073-00	RES,CHIP	10K 5% 1/10W
Q506	8-729-820-73	TRANSISTOR 2SC3746		R028	1-216-065-00	RES,CHIP	4.7K 5% 1/10W
Q507	8-729-035-54	TRANSISTOR 2SJ449		R029	1-216-089-91	RES,CHIP	47K 5% 1/10W



REF.NO.	PART NO.	DESCRIPTION	REMARK	REF.NO.	PART NO.	DESCRIPTION	REMARK
R030	1-216-017-91	RES,CHIP	47	5%	1/10W	R086	1-216-049-91 RES,CHIP 1K 5% 1/10W
R031	1-216-073-00	RES,CHIP	10K	5%	1/10W	R088	1-216-057-00 RES,CHIP 2.2K 5% 1/10W
R032	1-216-675-11	METAL CHIP	10K	0.50%	1/10W	R089	1-216-057-00 RES,CHIP 2.2K 5% 1/10W
R033	1-216-017-91	RES,CHIP	47	5%	1/10W	R090	1-216-057-00 RES,CHIP 2.2K 5% 1/10W
R034	1-216-025-91	RES,CHIP	100	5%	1/10W	R092	1-216-057-00 RES,CHIP 2.2K 5% 1/10W
R035	1-216-049-91	RES,CHIP	1K	5%	1/10W	R094	1-216-057-00 RES,CHIP 2.2K 5% 1/10W
R036	1-216-025-91	RES,CHIP	100	5%	1/10W	R096	1-216-671-11 METAL CHIP 6.8K 0.50%1/10W
R037	1-216-686-11	METAL CHIP	30K	0.50%	1/10W	R097	1-216-057-00 RES,CHIP 2.2K 5% 1/10W
R038	1-216-685-11	METAL CHIP	27K	0.50%	1/10W	R101	1-216-049-91 RES,CHIP 1K 5% 1/10W
R039	1-216-049-91	RES,CHIP	1K	5%	1/10W	R501	1-216-065-00 RES,CHIP 4.7K 5% 1/10W
R040	1-216-049-91	RES,CHIP	1K	5%	1/10W	R502	1-216-057-00 RES,CHIP 2.2K 5% 1/10W
R041	1-216-065-00	RES,CHIP	4.7K	5%	1/10W	R503	1-216-041-00 RES,CHIP 470 5% 1/10W
R042	1-216-089-91	RES,CHIP	47K	5%	1/10W	R504	1-216-057-00 RES,CHIP 2.2K 5% 1/10W
R043	1-216-065-00	RES,CHIP	4.7K	5%	1/10W	R505	1-216-041-00 RES,CHIP 470 5% 1/10W
R044	1-216-095-00	RES,CHIP	82K	5%	1/10W	R506	1-249-397-11 CARBON 22 5% 1/4W F
R045	1-216-073-00	RES,CHIP	10K	5%	1/10W	R507	1-216-065-00 RES,CHIP 4.7K 5% 1/10W
R046	1-216-675-11	METAL CHIP	10K	0.50%	1/10W	R508	1-216-025-91 RES,CHIP 100 5% 1/10W
R047	1-216-073-00	RES,CHIP	10K	5%	1/10W	R509	1-216-057-00 RES,CHIP 2.2K 5% 1/10W
R048	1-216-049-91	RES,CHIP	1K	5%	1/10W	R510	1-216-065-00 RES,CHIP 4.7K 5% 1/10W
R049	1-216-049-91	RES,CHIP	1K	5%	1/10W	R511	1-219-726-11 METAL 2.2 5% 10W
R050	1-216-025-91	RES,CHIP	100	5%	1/10W	R512	1-216-627-11 METAL CHIP 100 0.50%1/10W
R051	1-216-679-11	METAL CHIP	15K	0.50%	1/10W	R513	1-215-860-11 METAL OXIDE 33 5% 1W F
R052	1-216-073-00	RES,CHIP	10K	5%	1/10W	R514	1-211-796-11 FUSIBLE 1 5% 1/2W F
R053	1-216-675-11	METAL CHIP	10K	0.50%	1/10W	R515	1-216-675-11 METAL CHIP 10K 0.50%1/10W
R054	1-216-675-11	METAL CHIP	10K	0.50%	1/10W	R516	1-247-815-91 CARBON 220 5% 1/4W
R055	1-216-089-91	RES,CHIP	47K	5%	1/10W	R517	1-216-065-00 RES,CHIP 4.7K 5% 1/10W
R056	1-216-671-11	METAL CHIP	6.8K	0.50%	1/10W	R518	1-216-097-91 RES,CHIP 100K 5% 1/10W
R057	1-216-679-11	METAL CHIP	15K	0.50%	1/10W	R519	1-216-393-00 METAL OXIDE 2.2 5% 3W F
R058	1-216-663-11	METAL CHIP	3.3K	0.50%	1/10W	R520	1-216-393-00 METAL OXIDE 2.2 5% 3W F
R059	1-216-065-00	RES,CHIP	4.7K	5%	1/10W	R521	1-249-413-11 CARBON 470 5% 1/4W F
R060	1-216-025-91	RES,CHIP	100	5%	1/10W	R522	1-216-423-11 METAL OXIDE 27 5% 1W F
R061	1-216-065-00	RES,CHIP	4.7K	5%	1/10W	R523	1-249-421-11 CARBON 2.2K 5% 1/4W F
R063	1-216-025-91	RES,CHIP	100	5%	1/10W	R524	1-215-869-11 METAL OXIDE 1K 5% 1W F
R064	1-216-025-91	RES,CHIP	100	5%	1/10W	R525	1-216-681-11 METAL CHIP 18K 0.50%1/10W
R065	1-216-025-91	RES,CHIP	100	5%	1/10W	R526	1-214-840-00 METAL 100 1% 1/2W
R066	1-216-025-91	RES,CHIP	100	5%	1/10W	R527	1-214-840-00 METAL 100 1% 1/2W
R067	1-216-025-91	RES,CHIP	100	5%	1/10W	R528	1-214-840-00 METAL 100 1% 1/2W
R068	1-216-025-91	RES,CHIP	100	5%	1/10W	R529	1-260-313-51 CARBON 56 5% 1/2W
R069	1-216-017-91	RES,CHIP	47	5%	1/10W	R530	1-249-437-11 CARBON 47K 5% 1/4W
R070	1-216-675-11	METAL CHIP	10K	0.50%	1/10W	R531	1-249-437-11 CARBON 47K 5% 1/4W
R071	1-216-049-91	RES,CHIP	1K	5%	1/10W	R532	1-249-437-11 CARBON 47K 5% 1/4W
R072	1-216-651-11	METAL CHIP	1K	0.50%	1/10W	R533	1-249-437-11 CARBON 47K 5% 1/4W
R073	1-216-295-91	SHORT	0			R534	1-249-437-11 CARBON 47K 5% 1/4W
R074	1-216-675-11	METAL CHIP	10K	0.50%	1/10W	R535	1-216-049-91 RES,CHIP 1K 5% 1/10W
R075	1-216-049-91	RES,CHIP	1K	5%	1/10W	R536	1-216-049-91 RES,CHIP 1K 5% 1/10W
R076	1-216-049-91	RES,CHIP	1K	5%	1/10W	R537	1-216-049-91 RES,CHIP 1K 5% 1/10W
R077	1-216-049-91	RES,CHIP	1K	5%	1/10W	R538	1-216-049-91 RES,CHIP 1K 5% 1/10W
R078	1-216-049-91	RES,CHIP	1K	5%	1/10W	R539	1-216-049-91 RES,CHIP 1K 5% 1/10W
R079	1-216-017-91	RES,CHIP	47	5%	1/10W	R540	1-216-073-00 RES,CHIP 10K 5% 1/10W
R080	1-216-017-91	RES,CHIP	47	5%	1/10W	R541	1-260-314-11 CARBON 68 5% 1/2W
R081	1-216-675-11	METAL CHIP	10K	0.50%	1/10W	R542	1-215-863-11 METAL OXIDE 100 5% 1W F
R082	1-216-049-91	RES,CHIP	1K	5%	1/10W	R543	1-216-640-11 METAL CHIP 360 0.50%1/10W
R083	1-216-057-00	RES,CHIP	2.2K	5%	1/10W	R544	1-260-085-11 CARBON 68 5% 1/2W
R084	1-216-025-91	RES,CHIP	100	5%	1/10W	R545	1-216-683-11 METAL CHIP 22K 0.50%1/10W
R085	1-216-025-91	RES,CHIP	100	5%	1/10W	R546	1-260-288-11 CARBON 0.47 5% 1/2W



REF.NO.	PART NO.	DESCRIPTION	REMARK	REF.NO.	PART NO.	DESCRIPTION	REMARK
R547	1-216-663-11	METAL CHIP	3.3K	0.50%	1/10W		
R548	1-215-443-00	METAL	8.2K	1%	1/4W		
R549	1-216-675-11	METAL CHIP	10K	0.50%	1/10W		
R550	1-260-288-11	CARBON	0.47	5%	1/2W		
R551	1-216-659-11	METAL CHIP	2.2K	0.50%	1/10W		
R552	1-216-057-00	RES,CHIP	2.2K	5%	1/10W		
R553	1-216-655-11	METAL CHIP	1.5K	0.50%	1/10W		
R554	1-216-675-11	METAL CHIP	10K	0.50%	1/10W		
R555	1-216-065-00	RES,CHIP	4.7K	5%	1/10W		
R556	1-216-674-11	METAL CHIP	9.1K	0.50%	1/10W		
R557	1-218-760-11	METAL CHIP	220K	0.50%	1/10W		
R558	1-216-683-11	METAL CHIP	22K	0.50%	1/10W		
R561	1-216-683-11	METAL CHIP	22K	0.50%	1/10W		
R562	1-249-401-11	CARBON	47	5%	1/4W	F	
R563	1-216-662-11	METAL CHIP	3K	0.50%	1/10W		
R564	1-216-697-91	METAL CHIP	82K	0.50%	1/10W		
R565	1-216-671-11	METAL CHIP	6.8K	0.50%	1/10W		
R566	1-260-311-11	CARBON	39	5%	1/2W		
R567	1-216-627-11	METAL CHIP	100	0.50%	1/10W		
R568	1-216-655-11	METAL CHIP	1.5K	0.50%	1/10W		
R571	1-216-381-11	METAL OXIDE	0.22	5%	3W	F	
R572	1-216-097-91	RES,CHIP	100K	5%	1/10W		
R573	1-216-097-91	RES,CHIP	100K	5%	1/10W		
R574	1-216-097-91	RES,CHIP	100K	5%	1/10W		
R575	1-216-097-91	RES,CHIP	100K	5%	1/10W		
R576	1-216-097-91	RES,CHIP	100K	5%	1/10W		
R577	1-216-057-00	RES,CHIP	2.2K	5%	1/10W		
R578	1-216-025-91	RES,CHIP	100	5%	1/10W		
R579	1-216-672-11	METAL CHIP	7.5K	0.50%	1/10W		
R580	1-216-073-00	RES,CHIP	10K	5%	1/10W		
R581	1-216-073-00	RES,CHIP	10K	5%	1/10W		
R582	1-216-073-00	RES,CHIP	10K	5%	1/10W		
R583	1-216-677-11	METAL CHIP	12K	0.50%	1/10W		
R584	1-216-081-00	RES,CHIP	22K	5%	1/10W		
R585	1-216-081-00	RES,CHIP	22K	5%	1/10W		
R586	1-216-049-91	RES,CHIP	1K	5%	1/10W		
R587	1-216-049-91	RES,CHIP	1K	5%	1/10W		
R588	1-216-097-91	RES,CHIP	100K	5%	1/10W		
R589	1-216-097-91	RES,CHIP	100K	5%	1/10W		
R590	1-216-675-11	METAL CHIP	10K	0.50%	1/10W		
R591	1-216-675-11	METAL CHIP	10K	0.50%	1/10W		
R594	1-249-437-11	CARBON	47K	5%	1/4W		
R595	1-249-437-11	CARBON	47K	5%	1/4W		
R596	1-216-683-11	METAL CHIP	22K	0.50%	1/10W		
R663	1-215-482-00	METAL	360K	1%	1/4W		
R664	1-215-459-00	METAL	39K	1%	1/4W		
R665	1-216-049-91	RES,CHIP	1K	5%	1/10W		
R667	1-216-041-00	RES,CHIP	470	5%	1/10W		
R669	1-216-671-11	METAL CHIP	6.8K	0.50%	1/10W		
R701	1-249-383-11	CARBON	1.5	5%	1/4W	F	
R702	1-216-057-00	RES,CHIP	2.2K	5%	1/10W		
R703	1-216-085-00	RES,CHIP	33K	5%	1/10W		
R704	1-249-383-11	CARBON	1.5	5%	1/4W	F	
R705	1-249-385-11	CARBON	2.2	5%	1/4W		
R706	1-216-093-00	RES,CHIP	68K	5%	1/10W		
R707	1-249-421-11	CARBON	2.2K	5%	1/4W		
R708	1-216-073-00	RES,CHIP	10K	5%	1/10W		
R709	1-216-473-11	METAL OXIDE	56	5%	3W	F	
R710	1-216-073-00	RES,CHIP	10K	5%	1/10W		
R715	1-216-077-00	RES,CHIP	15K	5%	1/10W		
R719	1-249-383-11	CARBON	1.5	5%	1/4W	F	
R720	1-260-292-11	CARBON	1	5%	1/2W		
R721	1-216-667-11	METAL CHIP	4.7K	0.50%	1/10W		
R722	1-216-691-11	METAL CHIP	47K	0.50%	1/10W		
R723	1-216-663-11	METAL CHIP	3.3K	0.50%	1/10W		
R724	1-214-798-21	METAL	1.8	1%	1/2W		
R725	1-214-798-21	METAL	1.8	1%	1/2W		
R726	1-216-675-11	METAL CHIP	10K	0.50%	1/10W		
R727	1-260-292-11	CARBON	1	5%	1/2W		
R728	1-249-381-11	CARBON	1	5%	1/4W	F	
R729	1-215-865-11	METAL OXIDE	220	5%	1W	F	
R730	1-219-746-11	CARBON	1K	5%	1/2W		
R731	1-216-073-00	RES,CHIP	10K	5%	1/10W		
R732	1-216-073-00	RES,CHIP	10K	5%	1/10W		
R733	1-219-746-11	CARBON	1K	5%	1/2W		
R734	1-215-881-11	METAL OXIDE	15	5%	2W	F	
R737	1-249-377-11	CARBON	0.47	5%	1/4W	F	
R738	1-249-377-11	CARBON	0.47	5%	1/4W	F	
R739	1-249-413-11	CARBON	470	5%	1/4W	F	
R741	1-249-430-11	CARBON	12K	5%	1/4W		
R742	1-249-419-11	CARBON	1.5K	5%	1/4W		
R743	1-216-049-91	RES,CHIP	1K	5%	1/10W		
R748	1-216-683-11	METAL CHIP	22K	0.50%	1/10W		
R749	1-216-049-91	RES,CHIP	1K	5%	1/10W		
R750	1-216-057-00	RES,CHIP	2.2K	5%	1/10W		
R751	1-216-065-00	RES,CHIP	4.7K	5%	1/10W		
R752	1-216-083-00	RES,CHIP	27K	5%	1/10W		
R753	1-219-720-11	METAL	10M	5%	1W		
R754	1-219-754-11	CARBON	680K	5%	1/2W		
R755	1-219-754-11	CARBON	680K	5%	1/2W		
R756	1-220-824-11	CARBON	270K	5%	1/2W		
R759	1-218-754-11	METAL CHIP	120K	0.50%	1/10W		
R776	1-216-049-91	RES,CHIP	1K	5%	1/10W		
R777	1-216-681-11	METAL CHIP	18K	0.50%	1/10W		
R778	1-216-667-11	METAL CHIP	4.7K	0.50%	1/10W		
R779	1-216-049-91	RES,CHIP	1K	5%	1/10W		
R784	1-216-081-00	RES,CHIP	22K	5%	1/10W		
R900	1-216-399-00	METAL OXIDE	6.8	5%	3W	F	
R901	1-216-057-00	RES,CHIP	2.2K	5%	1/10W		
R902	1-216-065-00	RES,CHIP	4.7K	5%	1/10W		
R903	1-216-073-00	RES,CHIP	10K	5%	1/10W		
R904	1-216-057-00	RES,CHIP	2.2K	5%	1/10W		
R905	1-216-025-91	RES,CHIP	100	5%	1/10W		
R906	1-216-065-00	RES,CHIP	4.7K	5%	1/10W		
R907	1-216-025-91	RES,CHIP	100	5%	1/10W		
R908	1-216-091-00	RES,CHIP	56K	5%	1/10W		
R909	1-216-689-11	RES,CHIP	39K	5%	1/10W		
R910	1-216-073-00	RES,CHIP	10K	5%	1/10W		
R911	1-216-049-91	RES,CHIP	1K	5%	1/10W		
R912	1-218-772-11	METAL CHIP	680K	0.50%	1/10W		

The components identified by shading and mark Δ are critical for safety. Replace only with part number specified.

Les composants identifiés par un trame Δ et une marque Δ sont critiques pour la sécurité. Ne les remplacer que par une pièce portant le numéro spécifié.



REF.NO.	PART NO.	DESCRIPTION	REMARK	REF.NO.	PART NO.	DESCRIPTION	REMARK
R913	1-219-748-11	CARBON	4.7K	5%	1/2W		
R914	1-219-510-11	CARBON	470K	5%	1/2W		
R915	1-249-437-11	CARBON	47K	5%	1/4W		
R916	1-249-429-11	CARBON	10K	5%	1/4W		
R917	1-216-073-00	RES,CHIP	10K	5%	1/10W		
R918	1-216-097-91	RES,CHIP	100K	5%	1/10W		
R919	1-216-025-91	RES,CHIP	100	5%	1/10W		
R920	1-249-401-11	CARBON	47	5%	1/4W	F	
R921	1-216-668-11	METAL CHIP	5.1K	0.50%	1/10W		
R922	1-216-041-00	RES,CHIP	470	5%	1/10W		
R923	1-216-675-11	METAL CHIP	10K	0.50%	1/10W		
R924	1-249-397-11	CARBON	22	5%	1/4W	F	
R925	1-216-653-11	METAL CHIP	1.2K	0.50%	1/10W		
R926	1-216-653-11	METAL CHIP	1.2K	0.50%	1/10W		
R927	1-216-073-00	RES,CHIP	10K	5%	1/10W		
R928	1-216-667-11	METAL CHIP	4.7K	0.50%	1/10W		
R929	1-216-033-00	RES,CHIP	220	5%	1/10W		
R930	1-216-033-00	RES,CHIP	220	5%	1/10W		
R933	1-216-683-11	METAL CHIP	22K	0.50%	1/10W		
R934	1-216-667-11	METAL CHIP	4.7K	0.50%	1/10W		
R937	1-219-727-11	METAL	68	5%	10W		
R940	1-249-393-11	CARBON	10	5%	1/4W	F	
R941	1-216-073-00	RES,CHIP	10K	5%	1/10W		
R980	1-216-049-91	RES,CHIP	1K	5%	1/10W		
R981	1-216-025-91	RES,CHIP	100	5%	1/10W		
R1001	1-216-073-00	RES,CHIP	10K	5%	1/10W		
R1003	1-216-049-91	RES,CHIP	1K	5%	1/10W		
R1004	1-216-049-91	RES,CHIP	1K	5%	1/10W		
R1005	1-216-049-91	RES,CHIP	1K	5%	1/10W		
R1006	1-216-049-91	RES,CHIP	1K	5%	1/10W		
R1007	1-216-049-91	RES,CHIP	1K	5%	1/10W		
R1009	1-216-097-91	RES,CHIP	100K	5%	1/10W		
R1011	1-216-073-00	RES,CHIP	10K	5%	1/10W		
R1012	1-216-049-91	RES,CHIP	1K	5%	1/10W		
R1013	1-216-049-91	RES,CHIP	1K	5%	1/10W		
R1014	1-216-049-91	RES,CHIP	1K	5%	1/10W		
R1015	1-216-295-91	SHORT	0				
R1016	1-216-049-91	RES,CHIP	1K	5%	1/10W		
R1017	1-216-065-00	RES,CHIP	4.7K	5%	1/10W		
R1020	1-216-049-91	RES,CHIP	1K	5%	1/10W		
R1021	1-216-049-91	RES,CHIP	1K	5%	1/10W		
R1022	1-216-295-91	SHORT	0				
R1023	1-216-295-91	SHORT	0				
R1024	1-216-295-91	SHORT	0				
R1025	1-249-389-11	CARBON	4.7	5%	1/4W	F	
R1026	1-249-389-11	CARBON	4.7	5%	1/4W	F	
R1027	1-216-065-00	RES,CHIP	4.7K	5%	1/10W		
R1028	1-216-049-91	RES,CHIP	1K	5%	1/10W		
R1501	1-216-057-00	RES,CHIP	2.2K	5%	1/10W		
R1502	1-216-073-00	RES,CHIP	10K	5%	1/10W		
R1503	1-216-125-00	RES,CHIP	1.5M	5%	1/10W		
R1504	1-216-097-91	RES,CHIP	100K	5%	1/10W		
R1513	1-216-049-91	RES,CHIP	1K	5%	1/10W		
R1514	1-216-049-91	RES,CHIP	1K	5%	1/10W		
						<RELAY>	
						RY501 1-755-137-11	RELAY
						<SPARK GAP>	
						SG701 1-519-422-11	GAP, SPARK
						SG702 1-519-422-11	GAP, SPARK
						SG901 1-517-499-21	GAP, SPARK
						<TRANSFORMER>	
						T501 1-429-303-21	TRANSFORMER, FERRITE (HDT)
						T502 1-416-401-11	INDUCTOR 0UH
						T503 1-431-413-11	TRANSFORMER, FERRITE (HST)
						T504 1-416-257-11	INDUCTOR 0UH
						T701 1-431-414-11	TRANSFORMER, FERRITE (DFT)
						T901 1-416-402-11	INDUCTOR 0UH
						T902 Δ X-4035-170-1	TRANSFORMER ASSY, FLYBACK (NX-4142//J1D4)
						<THERMISTOR>	
						TH501 1-807-796-11	THERMISTOR
						TH502 1-807-796-11	THERMISTOR
						<CRYSTAL>	
						X001 1-567-781-61	VIBRATOR, CRYSTAL

						* 8-933-298-00	H1 BOARD, COMPLETE *****
						<CAPACITOR>	
						C805 1-124-589-11	ELECT 47MF 20% 16V
						C811 1-124-589-11	ELECT 47MF 20% 16V
						<CONNECTOR>	
						CN801*1-564-526-11	PLUG, CONNECTOR 11P
						CN802*1-564-509-11	PLUG, CONNECTOR 6P
						<DIODE>	
						D810 8-719-064-11	DIODE SPR-325MVW
						<TRANSISTOR>	
						Q801 8-729-120-28	TRANSISTOR 2SC1623-L5L6
						Q802 8-729-120-28	TRANSISTOR 2SC1623-L5L6



REF.NO.	PART NO.	DESCRIPTION	REMARK	REF.NO.	PART NO.	DESCRIPTION	REMARK
C5301	1-164-004-11	CERAMIC CHIP 0.1MF	10% 25V	R5005	1-216-689-11	RES,CHIP 39K	5% 1/10W
C5303	1-164-004-11	CERAMIC CHIP 0.1MF	10% 25V	R5006	1-216-073-00	RES,CHIP 10K	5% 1/10W
C5304	1-164-004-11	CERAMIC CHIP 0.1MF	10% 25V	R5007	1-216-049-91	RES,CHIP 1K	5% 1/10W
C5305	1-104-664-11	ELECT 47MF	20% 25V	R5008	1-216-295-91	SHORT 0	
C5306	1-164-004-11	CERAMIC CHIP 0.1MF	10% 25V	R5009	1-216-295-91	SHORT 0	
C5307	1-137-399-11	FILM 0.1MF	5% 50V	R5010	1-216-295-91	SHORT 0	
C5308	1-164-004-11	CERAMIC CHIP 0.1MF	10% 25V	R5011	1-216-073-00	RES,CHIP 10K	5% 1/10W
C5309	1-164-004-11	CERAMIC CHIP 0.1MF	10% 25V	R5012	1-216-295-91	SHORT 0	
C5310	1-104-664-11	ELECT 47MF	20% 25V	R5013	1-216-295-91	SHORT 0	
C5311	1-137-399-11	FILM 0.1MF	5% 50V	R5015	1-216-049-91	RES,CHIP 1K	5% 1/10W
C5401	1-164-004-11	CERAMIC CHIP 0.1MF	10% 25V	R5101	1-249-383-11	CARBON 1.5	5% 1/4W F
C5403	1-164-232-11	CERAMIC CHIP 0.01MF	10% 50V	R5102	1-249-383-11	CARBON 1.5	5% 1/4W F
C5404	1-164-004-11	CERAMIC CHIP 0.1MF	10% 25V	R5108	1-216-308-00	RES,CHIP 4.7	5% 1/10W
C5405	1-104-664-11	ELECT 47MF	20% 25V	R5109	1-216-308-00	RES,CHIP 4.7	5% 1/10W
C5406	1-164-004-11	CERAMIC CHIP 0.1MF	10% 25V	R5110	1-216-073-00	RES,CHIP 10K	5% 1/10W
C5407	1-137-399-11	FILM 0.1MF	5% 50V	R5111	1-216-308-00	RES,CHIP 4.7	5% 1/10W
C5408	1-163-003-11	CERAMIC CHIP 330PF	10% 50V	R5112	1-249-383-11	CARBON 1.5	5% 1/4W F
C5409	1-164-004-11	CERAMIC CHIP 0.1MF	10% 25V	R5113	1-216-073-00	RES,CHIP 10K	5% 1/10W
C5410	1-104-664-11	ELECT 47MF	20% 25V	R5114	1-249-441-11	CARBON 100K	5% 1/4W F
C5412	1-164-004-11	CERAMIC CHIP 0.1MF	10% 25V	R5115	1-215-882-00	METAL OXIDE 22	5% 2W F
C5501	1-126-923-11	ELECT 220MF	20% 10V	R5116	1-216-073-00	RES,CHIP 10K	5% 1/10W
<CONNECTOR>				R5117	1-216-308-00	RES,CHIP 4.7	5% 1/10W
CN5001*1-564-512-11	PLUG, CONNECTOR 9P			R5119	1-216-073-00	RES,CHIP 10K	5% 1/10W
CN5002*1-564-509-11	PLUG, CONNECTOR 6P			R5120	1-249-383-11	CARBON 1.5	5% 1/4W F
CN5003 1-564-513-11	PLUG, CONNECTOR 10P			R5121	1-249-441-11	CARBON 100K	5% 1/4W F
CN5004*1-564-507-11	PLUG, CONNECTOR 4P			R5122	1-215-882-00	METAL OXIDE 22	5% 2W F
<DIODE>				R5201	1-249-383-11	CARBON 1.5	5% 1/4W F
D5002 8-719-801-78	DIODE 1SS184			R5202	1-249-383-11	CARBON 1.5	5% 1/4W F
D5101 8-719-800-76	DIODE 1SS226			R5203	1-249-383-11	CARBON 1.5	5% 1/4W F
D5103 8-719-800-76	DIODE 1SS226			R5204	1-249-441-11	CARBON 100K	5% 1/4W F
D5201 8-719-800-76	DIODE 1SS226			R5205	1-216-073-00	RES,CHIP 10K	5% 1/10W
D5301 8-719-800-76	DIODE 1SS226			R5206	1-215-859-00	METAL OXIDE 22	5% 1W F
D5303 8-719-800-76	DIODE 1SS226			R5207	1-216-073-00	RES,CHIP 10K	5% 1/10W
D5401 8-719-800-76	DIODE 1SS226			R5208	1-216-670-11	METAL CHIP 6.2K	0.50%1/10W
D5403 8-719-800-76	DIODE 1SS226			R5301	1-249-383-11	CARBON 1.5	5% 1/4W F
D5501 8-719-976-96	DIODE DTZ4.7C			R5302	1-249-383-11	CARBON 1.5	5% 1/4W F
<SENSOR>				R5308	1-216-308-00	RES,CHIP 4.7	5% 1/10W
GS50011-475-592-11	SENSOR UNIT, MAGNETIC			R5309	1-216-308-00	RES,CHIP 4.7	5% 1/10W
<IC>				R5310	1-216-073-00	RES,CHIP 10K	5% 1/10W
IC5101 8-759-822-38	IC LA6510			R5311	1-216-308-00	RES,CHIP 4.7	5% 1/10W
IC5201 8-759-803-42	IC LA6500-FA			R5312	1-249-383-11	CARBON 1.5	5% 1/4W F
IC5301 8-759-822-38	IC LA6510			R5313	1-216-073-00	RES,CHIP 10K	5% 1/10W
IC5401 8-759-822-38	IC LA6510			R5314	1-249-441-11	CARBON 100K	5% 1/4W F
<RESISTOR>				R5315	1-215-882-00	METAL OXIDE 22	5% 2W F
R5001 1-249-383-11	CARBON 1.5	5%	1/4W F	R5316	1-216-073-00	RES,CHIP 10K	5% 1/10W
R5003 1-216-295-91	SHORT 0			R5317	1-216-308-00	RES,CHIP 4.7	5% 1/10W
				R5319	1-216-073-00	RES,CHIP 10K	5% 1/10W
				R5320	1-249-383-11	CARBON 1.5	5% 1/4W F
				R5321	1-249-441-11	CARBON 100K	5% 1/4W F
				R5322	1-215-882-00	METAL OXIDE 22	5% 2W F
				R5401	1-249-383-11	CARBON 1.5	5% 1/4W F
				R5402	1-249-383-11	CARBON 1.5	5% 1/4W F
				R5406	1-216-689-11	RES,CHIP 39K	5% 1/10W
				R5407	1-216-079-00	RES,CHIP 18K	5% 1/10W
				R5408	1-216-308-00	RES,CHIP 4.7	5% 1/10W

GDM-5010PT



REF.NO.	PART NO.	DESCRIPTION		REMARK
R5409	1-216-308-00	RES,CHIP	4.7	5% 1/10W
R5410	1-216-089-91	RES,CHIP	47K	5% 1/10W
R5411	1-216-308-00	RES,CHIP	4.7	5% 1/10W
R5412	1-249-383-11	CARBON	1.5	5% 1/4W F
R5413	1-216-097-91	RES,CHIP	100K	5% 1/10W
R5414	1-249-441-11	CARBON	100K	5% 1/4W F
R5415	1-215-886-11	METAL OXIDE	100	5% 2W F
R5416	1-216-077-00	RES,CHIP	15K	5% 1/10W
R5417	1-216-308-00	RES,CHIP	4.7	5% 1/10W
R5419	1-216-089-91	RES,CHIP	47K	5% 1/10W
R5420	1-249-383-11	CARBON	1.5	5% 1/4W F
R5421	1-249-441-11	CARBON	100K	5% 1/4W F
R5422	1-215-885-00	METAL OXIDE	68	5% 2W F
R5423	1-216-105-91	RES,CHIP	220K	5% 1/10W
R5501	1-216-057-00	RES,CHIP	2.2K	5% 1/10W
R5502	1-216-681-11	METAL CHIP	18K	0.50%1/10W
R5503	1-216-681-11	METAL CHIP	18K	0.50%1/10W
R5504	1-216-093-00	RES,CHIP	68K	5% 1/10W
R5505	1-216-067-00	RES,CHIP	5.6K	5% 1/10W
R5506	1-216-670-11	METAL CHIP	6.2K	0.50%1/10W